



array
reinvented.

CURV 500[®]

PORTABLE **ARRAY SYSTEM**



**PRO AUDIO
IN MOTION**

CONNECT THESE 3 FOR EXCELLENCE



Up to 4 CURV 500® Array Satellites

CURV 500® SmartLink® Adapter



CURV 500® Subwoofer with control panel



CURV 500®
Portable Array System
Entertainer Set

The CURV 500® is an innovative system, uniquely combining portability, sound perfection and ease of use. The system comprises 3 components that can be connected with ease.

It is based around the SmartLink® adapter. Up to four Array Satellites can be effortlessly interconnected with the LD Systems-patented click mechanism delivering plug-and-play convenience. The adapter also provides the connection to the subwoofer, which serves as a control unit for the entire system, acting both as traditional bass box and mixing desk.

GUESS WHY IT'S CALLED "SMARTLINK®"?



The innovative SmartLink® adapter forms the basis of the system. On top of that up to four Array Satellites can be effortlessly interconnected with the LD Systems-patented click mechanism: simply press the connection button, join the two modules by their guide rails and release the button to engage.

Easy-Click? Plug-and-Play? Whatever. Connected in 2 seconds is what counts. That's at least what our engineers thought. The mechanical connection also provides signal transmission: no other cables are needed.



SIZE: XS
SOUND: XL!

The speaker columns are equipped with up to four modular array satellites arranged in a curve. The result is extremely clear, three-dimensional sound – similar to the sound generated by large line arrays.



Even a single 12 x 12 cm array satellite produces excellent sound results. This is guaranteed by LD Systems' in-house developed WaveAhead® technology, whereby three tweeters are arranged vertically in front of a high power fullrange driver, perfectly blending and dispersing the sound.

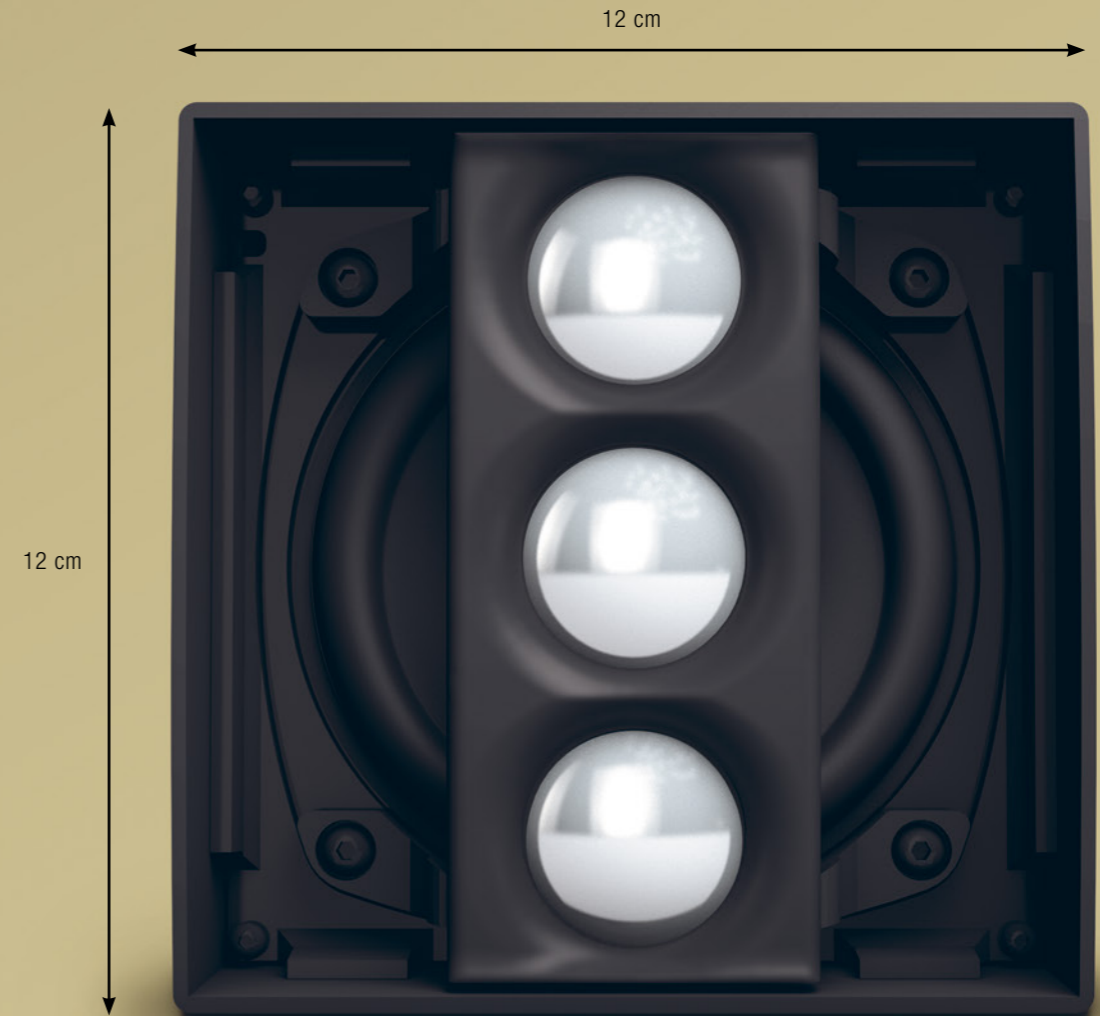

Actual Size

SOUND TO GO.



The CURV 500® is the first truly portable modular array system. Sophisticated technology, elegant design and a modularity that enables it to be transported conveniently and compactly.

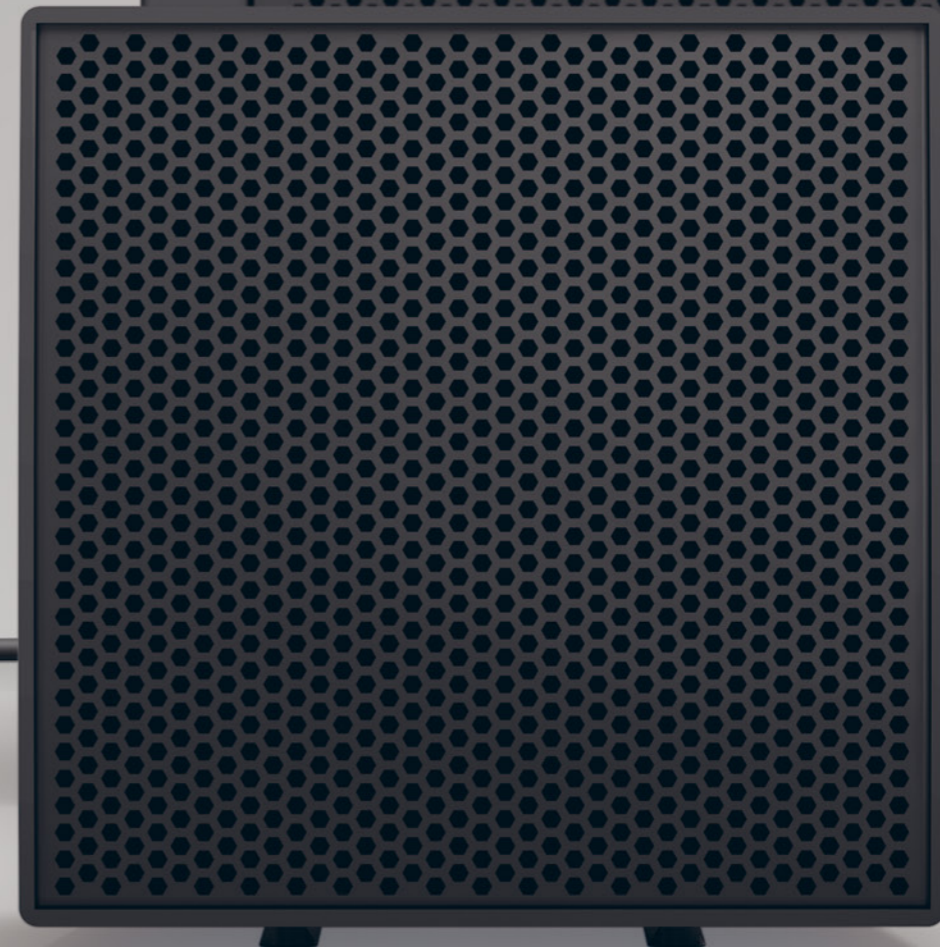

Actual Size

A masterpiece of design technology and simplicity: the aluminium unibody construction of the CURV 500® array satellites sets new standards and is an essential component of the system's outstanding audio quality.

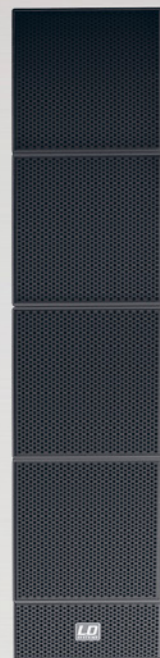

Singer-songwriters, jazz musicians, entertainers, speakers: everyone loves technology that fits into any trunk, is simply to assemble and produces the very best results. Like the new CURV 500®.



istockphoto.com/RapidEye

The integrated 4-channel mixing desk provides connectivity for microphones, instruments and laptops. Its built-in Bluetooth® technology permits wireless data transmission from smartphones or tablets and digital sound effects can also be generated via the 24-bit processor.

DESIGNED TO MAKE YOUR LIFE EASIER.

Subwoofer with integrated 4-Channel Mixer

1x Mic/Hi-Z (XLR/6,3mm Jack Combo)	2 x Array Satellite Out (Speakon compatible)	DFX (Ch1-2)
1x Mic (XLR/6,3mm Jack Combo)	Line Out (XLR)	DFX Presets
2x Line (XLR/6,3mm Jack Combo)	System Out (5-pin XLR)	DSP Presets
3,5 mm Jack	Input Level (Ch1-4)	Bluetooth® Link 
	Hi-Z	Mono/Stereo
	Hi/Low EQ (Ch1-2)	Sub Level
		Main Level



back view



top view

POWER TO THE PEOPLE.

The CURV 500® is an all-rounder – for music and for speaking. It provides a big live music sound, is a DJ's high-performance powerhouse and delivers clear spoken words and lectures. Thanks to its versatility, it is also ideal for use on exhibition stands, in clubs and smaller spaces. It represents an ideal, ultra-portable unit for stand-alone entertainers, bands and speakers and always delivers the right sound – indoors and outdoors. One way or another: the audience listens. With pleasure.



Extremely high-performance
as a double pack:
the CURV 500® Power Set.



The CURV 500® feels at home wherever there's music playing: in bars, clubs, studios and even as a home entertainment system. It can be permanently installed with versatile wall and ceiling bracket systems wherever perfect sound quality is called for. This is where the benefits of the compact CURV 500® come into their own.

isoboprote.com/architectphoto

GREAT SOUND CAN BE INSTALLED.

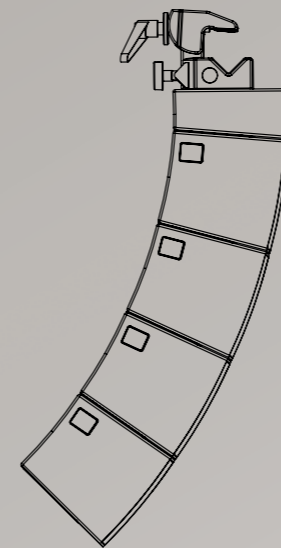

Clamp for Truss

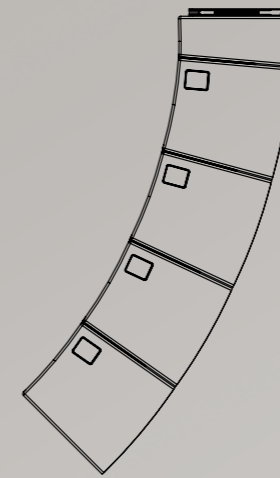

Ceilingmount

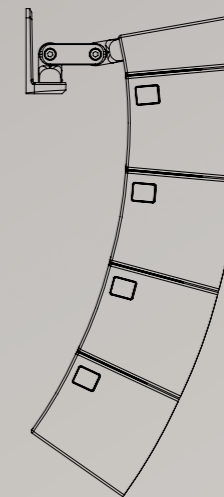

Wallmount downward

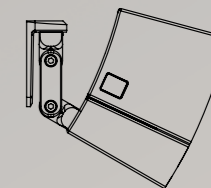

Wallmounted upward

The brackets can be fixed to the wall or ceiling. Wall-mounted, the line array can be assembled from the floor up or even suspended.

One system – several options. The CURV 500® can be installed on the wall or ceiling, depending on the configuration of the space. Up to 4 Array Satellites can be combined, in ascending or descending order, using the discreet fixing modules. Whatever works best!

SPECIFICATIONS

MODEL NAME	CURV 500°ES	CURV 500°AVS	CURV 500°PS
TYPE:	Portable Array System Entertainer Set Including Distance Bar & Speaker Cable	Portable Array System AV Set Including Speaker Cables	Portable Array System Power Set Including Distance Bars & Speaker Cables
RATED SYSTEM POWER (RMS):	460 W	380 W	920 W
NUMBER OF ARRAY SATELLITES:	4	2	8
NUMBER OF SMARTLINK® ADAPTERS:	1	2	2
NUMBER OF SUBWOOFERS:	1	1	2
MAX. SPL (CONTINUOUS):	122 dB	116 dB	128 dB
MAX. SPL (PEAK):	128 dB	122 dB	134 dB
SUBWOOFER:	10" bass reflex		
SATELLITE:	MF: 1 x 4" / HF: 3 x 1" with WaveAhead® Technology / 16 ohms		
FREQUENCY RESPONSE:	47 Hz - 20 kHz		
DISPERSION (H X V):	110° horizontal, 15° vertical per satellite		
AMPLIFICATION:	Class D		
POWER OUTPUT (RMS/PEAK):	Subwoofer: 300 W / 1200 W Satellite: 2 x 160 W / 2 x 640 W	Subwoofer: 300 W / 1200 W, Satellite: 2 x 160 W / 2 x 640 W Subwoofer Extension: 300 W / 1200 W, 1 x 160 W / 1 x 640 W (Satellite)	
PROTECTION:	DSP based multiband-limiter, Short Circuit, Overheating, Over-current		
SUBWOOFER FEATURES:	4 channel mixer, Bluetooth®, 16 DFX Presets, 4 System DSP Presets, threaded M20 Flange, 3 ergonomic handles		
SUBWOOFER CONTROLS:	Input Level (Ch1-4), Hi-Z, Hi/Low EQ (Ch1-2), DFX (Ch1-2), DFX Presets, DSP Presets, Bluetooth Link, Mono/Stereo, Sub Level, Main Level		
SUBWOOFER INDICATORS:	Signal, Limit, Bluetooth®, Power		
SUBWOOFER CONNECTORS:	1x Mic/Hi-Z (XLR/6,3mm Jack Combo), 1x Mic (XLR/6,3mm Jack Combo), 2x Line (XLR/6,3mm Jack Combo), 3,5mm Jack, 2 x Array Satellite Out (Speakon compatible), Line Out (XLR), System Out (5-pin XLR)		
SUBWOOFER MATERIAL:	Plywood		
SUBWOOFER SURFACE:	PA Painting		
ARRAY SATELLITE FEATURES:	WaveAhead® Technology, internal crossover, metal grille		
ARRAY SATELLITE MATERIAL:	Diecast Aluminium		
ARRAY SATELLITE SURFACE:	Powder coating		
SMARTLINK® ADAPTER FEATURES:	dual 16 mm #ange, 2x M6 thread for optional wall mount		
SMARTLINK® ADAPTER CONNECTORS:	1x Speakon compatible, 1x Phoenix		
SMARTLINK® ADAPTER MATERIAL:	Diecast Aluminium		
SMARTLINK® ADAPTER SURFACE:	Powder coating		
SUBWOOFER DIMENSIONS (W X H X D):	325 x 383 x 491 mm		
ARRAY SATELLITE DIMENSIONS (W X H X D):	122 x 122 x 122 mm		
SMARTLINK® ADAPTER DIMENSIONS (W X H X D):	122 x 57 x 122 mm		
SUBWOOFER WEIGHT:	16,5 kg		
ARRAY SATELLITE WEIGHT:	1,7 kg		
SMARTLINK® ADAPTER WEIGHT:	0,6 kg		

BIG TECHNOLOGY: COMPACT DIMENSIONS

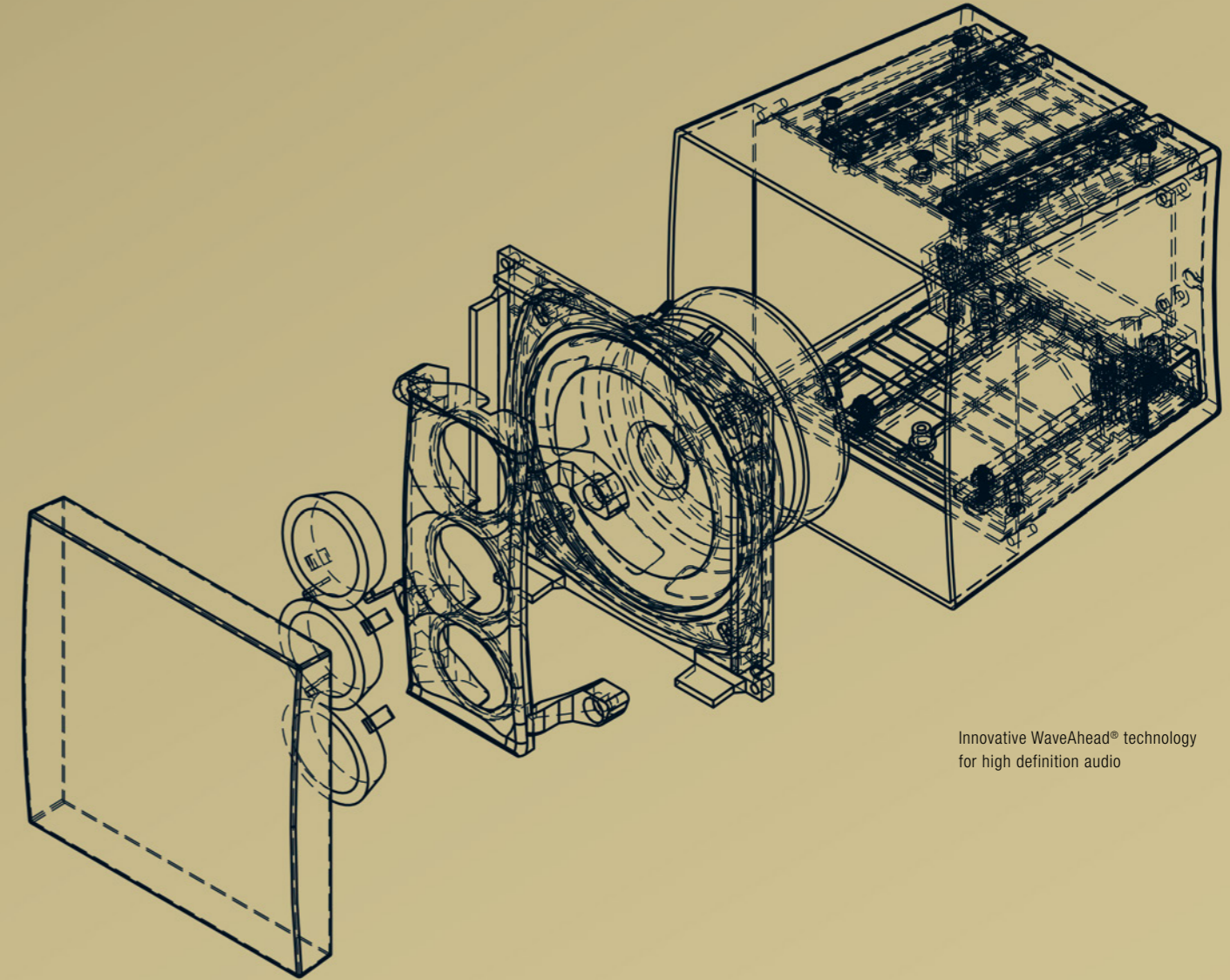

Innovative WaveAhead® technology for high definition audio

SETS & EXTENSIONS



CURV 500°ES
Portable Array System
Entertainer Set



CURV 500°PS
Portable Array System
Power Set



CURV 500°AVS
Portable Array System
A/V Set



Power Extension Set
Composed of 1 Subwoofer
Extension + 4 Array Satellites
+ SmartLink® Adapter +
Distance Bar + Speaker Cable.



Stereo Set
Composed of a SmartLink®
Adapter + distance bar +
Speaker stand base + Cable.



SmartLink® adapter
For CURV 500° portable
Array System



2 x Array Satellites
For CURV 500° portable
Array System



Distance Bar
For CURV 500° portable
Array System



Subwoofer Extension
For CURV 500° portable
Array System



Speaker Stand Base
For CURV 500° portable
Array System

GREAT SOUND MADE PORTABLE.

CHECK IT OUT!



www.facebook.com/ldsystems
www.youtube.com/ldsystemsvideos
blog.adamhall.com



WWW.LD-SYSTEMS.COM

LD Systems® is a brand of the Adam Hall Group

The information contained in this publication, including numerical data, has been prepared as a general guide to the products, but intending buyers and users must satisfy themselves as to the suitability and the safety of the products for their particular purposes and duties. No responsibility is assumed for any errors herein. The company reserves the right to alter the designs and material specifications of products shown in this publication without notice.

YOUR LOCAL DEALER:

