

multi/poly

ANALOG MODELING SYNTHESIZER

Owner's Manual

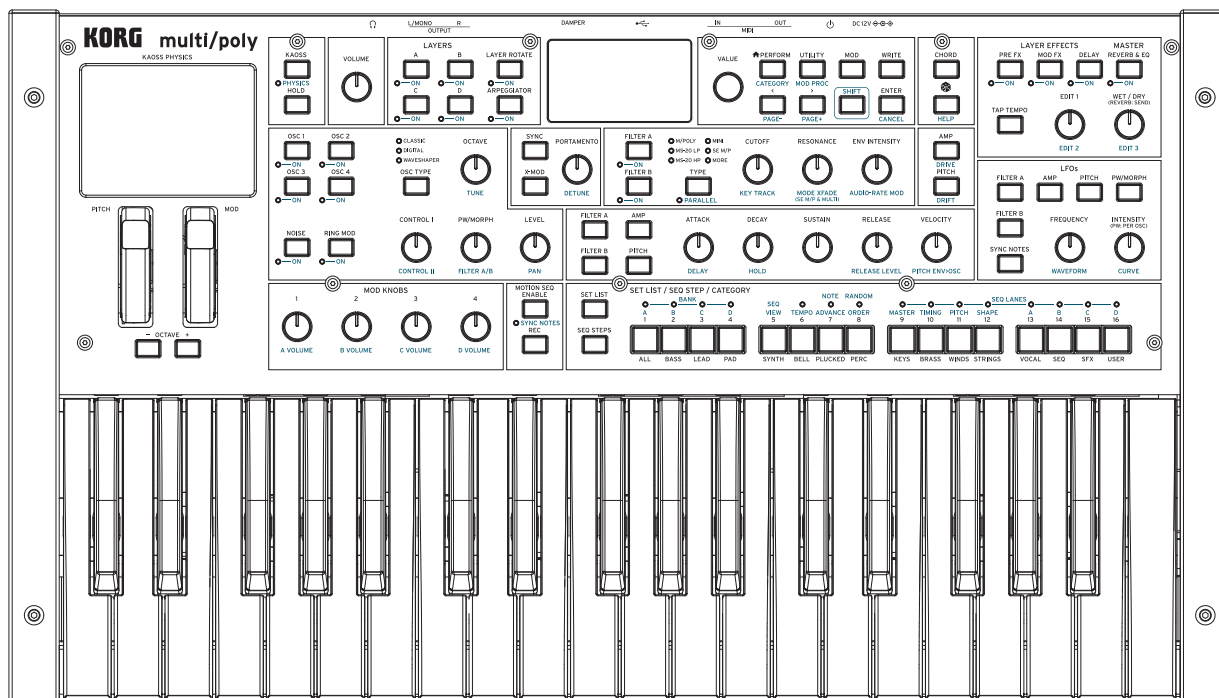

KORG

Contents

Getting Started	1
About the multi/poly manuals	1
Main Features	1
If you don't usually read manuals.....	1
Navigation	1
SHIFT	2
Double-press	3
ENTER for accelerated editing	3
Modulation	3
Mod Knobs	3
Help pages	3
Structure	3
Selecting and Playing Sounds	4
Selecting Sounds	4
Selecting Performances from the display	4
Selecting from lists	4
Using Set Lists	5
Assigning a Performance to a Set List Slot	6
Saving Set Lists	6
Basic Editing	7
Home Page (PERFORM)	7
Layer Programs	7
Velocity Zones	8
Keyboard Zones	8
Program Setup	9
Voice Assign	10
Layer Setup	12
Performance Setup	13
Write	14
Saving Sounds	14
Name	15
Editing names	15
Write Metadata	15
Compare	16
Using Compare	16
Delete from Database	16
Using Delete	16
Oscillators	18
Oscillator 1/2/3/4	18
Overview	18
Front panel controls	18
Classic Type: Osc 1/2/3/4 Waveform	19
Classic Type: Osc 1/2/3/4 Morph	20
Classic Type: Osc 1/2/3/4 Details	21
Digital Type: Osc 1/2/3/4 Waveform	22
Digital Type: Osc 1/2/3/4 Morph	25
Digital Type: Osc 1/2/3/4 Details	26
Waveshaper Type: Osc 1/2/3/4 Waveform	27
Waveshaper Type: Osc 1/2/3/4 Morph	31
Waveshaper Type: Osc 1/2/3/4 Details	32
Noise Generator	32
Ring Modulator	33
Sync	34
X-Mod (Cross Modulation)	36
Mixer 1	37
Osc 1/2/3/4	37
Mixer 2	38
Noise (Noise Generator) and Ring Mod (Ring Modulator)	38

Contents

Stereo	38
Filters	39
Serial and Parallel routing	39
Filter A/B Balance	39
Filter overview	40
The basic filter types: LP, HP, BP, BR	40
Important: a note about gain	40
Filter A/B	41
2-Pole LP/HP/BP/BR	42
4-Pole LP/HP/BP/BR	43
SE M/P	43
Multi Filter	44
Multi Filter A/B	44
What's a Multi Filter?	44
Manual	45
Filter A/B Mod	46
Default modulation routings	46
Audio-rate modulation	46
Filter A/B Key Track	47
How Key Track works: Keys and Slopes	47
Pitch	50
Osc Pitch	50
Osc 1/2/3/4	50
Common Pitch	50
Portamento	51
Common Pitch Mod	52
Amp	53
Amp	53
Amp Key Track	55
Drive	56
Drift	57
Drift/Voice Variation	57
Virtual voice cards and drift	57
Voice Variation	57
Modulation	59
Using Modulation	59
Modulation Overview	59
Adding Modulation Routings	59
Viewing and Editing Modulations	60
Mod Knobs	62
Modulation Sources	62
Controllers	62
Mod Knobs	64
Generators	64
CC +	65
CC +/-	65
Envelopes	66
Filter A/Filter B/Pitch/Amp Envelope	66
Filter A/Filter B/Pitch/Amp Envelope Curve	67
Filter A/Filter B/Pitch/Amp Envelope Trigger	68
LFOs	70
Overview	70
Filter A, Filter B, Amp, Pitch, and PW/Morph LFO	70
Filter A, Filter B, Amp, Pitch, and PW/Morph LFO Details	73
Modulation Processors	75
Overview	75
Gate	75
Offset	76
Quantize	77
Scale	78

Contents

Curve	78
Smooth	80
Sum	80
Motion Sequencing 2.0	82
What is Motion Sequencing 2.0?	82
Motion Seq Overview	83
Motion Sequence Recording	84
Step recording Pitch	84
Real-time recording for Seq Lanes A-D	84
Motion Sequence editing	86
Editing Lanes	86
Editing Steps	86
Step Solo mode	86
Motion Sequencer	87
Master Lane	88
Standard Lane Controls	89
Step Probability	89
Timing Lane probability	89
Timing	90
Timing Lane	90
Timing Lane Step	91
Pitch	92
Pitch Lane	92
Pitch Lane Step	94
Shape	95
Shape Lane	95
Shape Lane Step	95
Seq A/B/C/D	96
Seq Lane	96
Seq Lane Step	97
Motion Sequence Utility	98
Cut Steps, Copy Steps, Paste Steps, Insert Steps	98
Clear	98
Scale Timing	98
Kaoss Physics	99
Overview	99
Using Kaoss Physics to create specific results	99
Kaoss Physics and MIDI	99
Kaoss Physics	100
Kaoss Physics Details	101
Kaoss Launch	102
Arpeggiator	103
Arpeggiator	103
Chord	105
Chord	105
Layer Rotate	106
Layer Rotate	106
Effects	108
Overview	108
Main page	108
Level controls	108
Reverb Sends	109
Edit page	109
Pre FX	110
Decimator	110
Graphic EQ	110
Guitar Amp	110
Modern Compressor	110
Parametric EQ	110
Red Compressor	110
Ring Modulator	110

Contents

Tremolo	110
Wave Shaper	110
Vintage Distortion	110
Mod FX	111
Black Chorus/Flanger	111
Black Phase	111
CX-3 Vibrato/Chorus	111
EP Chorus	111
Harmonic Chorus	111
Modern Chorus	111
Modern Phaser	111
Orange Phase	111
Orange Phase V2	111
Polysix Ensemble	111
Small Phase	111
Talking Modulator	111
Vintage Chorus	112
Vintage Flanger	112
Vintage/Custom Wah	112
Vox Wah	112
CX-3 Rotary Speaker	112
Delay	112
L/C/R Delay	112
Multiband Mod. Delay	112
Reverse Delay	112
Stereo/Cross Delay	112
Tape Echo	112
Master Reverb	113
Early Reflections	113
Overb	113
Master EQ	113
L (Low) and H (High)	113
Mid 1 and Mid 2	114
Randomize	115
Using Randomize	115
Utility	116
System Setup	116
MIDI & USB	117
Controllers	118
MIDI CC Assign	120
Global Scale	121
Preferences	122
System Stats	123
About	123
USB	124
MIDI	124
Editor/Librarian	124
Specifications	125
MIDI Implementation Chart	126

Getting Started

Thank you for purchasing the Korg multi/poly Analog Modeling Synthesizer.

About the multi/poly manuals

The documentation for the multi/poly consists of the following:

- Quick Start Guide
- Owner's Manual (what you're reading now)

In this manual, the following text styles indicate:

- **FRONT PANEL CONTROLS**
- **Parameter Names**
- *Parameter Values*

Main Features

Inspired by KORG's classic Mono/Poly and its combination of big sounds and modular-derived experimental features, the multi/poly produces amazing analog timbres with the flexibility, power, and high polyphony that only digital technology can provide.

- Create hardware mash-ups with classic analog, digital wavetable, and wave-shaper oscillators, a selection of next-generation modeled filters, modeled portamento, modeled envelopes, and modeled VCAs.
- Programs include four oscillators, a noise generator, dual filters, and three insert effects, plus a massively flexible modulation system with four looping DAHDSR envelopes, five LFOs, six Mod Processors, three key-track generators, and multi-lane Motion Sequencing 2.0.
- Performances layer four Programs at once, adding master reverb & EQ, another two Mod Processors, and Kaoss Physics.
- Layer Rotate triggers new Programs with each press of a key.
- Motion Sequencing 2.0 runs individual sequences for each voice. Easily record knob movements in real-time. Timing, Pitch, Shape, and four sets of Step Sequence values are separated into "lanes." Each lane can have a different number of steps. Modulate loop points, step probabilities, and more on a per-note basis.
- Kaoss Physics combines hands-on modulation control with interactive game-style physics including gravity, reflection, absorption, and friction.
- Mod Knobs make it easy to control sounds and make them your own.
- Smooth Sound Transitions let previously-played voices and effects ring out naturally when you change sounds.

If you don't usually read manuals...

Even if you don't usually read manuals, please read this section!

Navigation

Press a button or turn a knob, and the display will show the related page. See "multi/poly page map" on page 2 for all of the pages in the UI and their associated front-panel controls.

Some pages, such as Oscillator Morph, are only displayed by turning a knob. Similarly, the **CHORD** button both edits a parameter and displays a page. To display these or any other pages without making an edit, hold **ENTER** and turn or press the related knob or button. The page will appear with the parameter selected, but the value will not be changed.

To go back to selecting sounds, press **PERFORM**. If you don't see the main page the first time, press **PERFORM** again; two presses will always bring you to the home page with the Performance name selected.

< > and **PAGE-/PAGE+** are the basic controls for moving around in the display.

< and **>** cursor through parameters, and can also select items in lists.

Getting Started

Hold **SHIFT** and press < or > to use **PAGE-** and **PAGE+**, which select pages in the display. There are page indicators in the upper right of the display; the filled-in circle shows the current page.

Title bar with selected Layer, Page Name, and Page Indicators



LAYER A/B/C/D: Layers contain a Program and a handful of other settings. The front panel edits one Layer at a time, as selected by these buttons. To turn a Layer on or off, hold **SHIFT** and press the Layer's button, or just double-press the button.

Most pages on the display apply only to the selected Layer. For these pages, the Layer's letter (A/B/C/D) is shown in the upper left of the display.

multi/poly page map

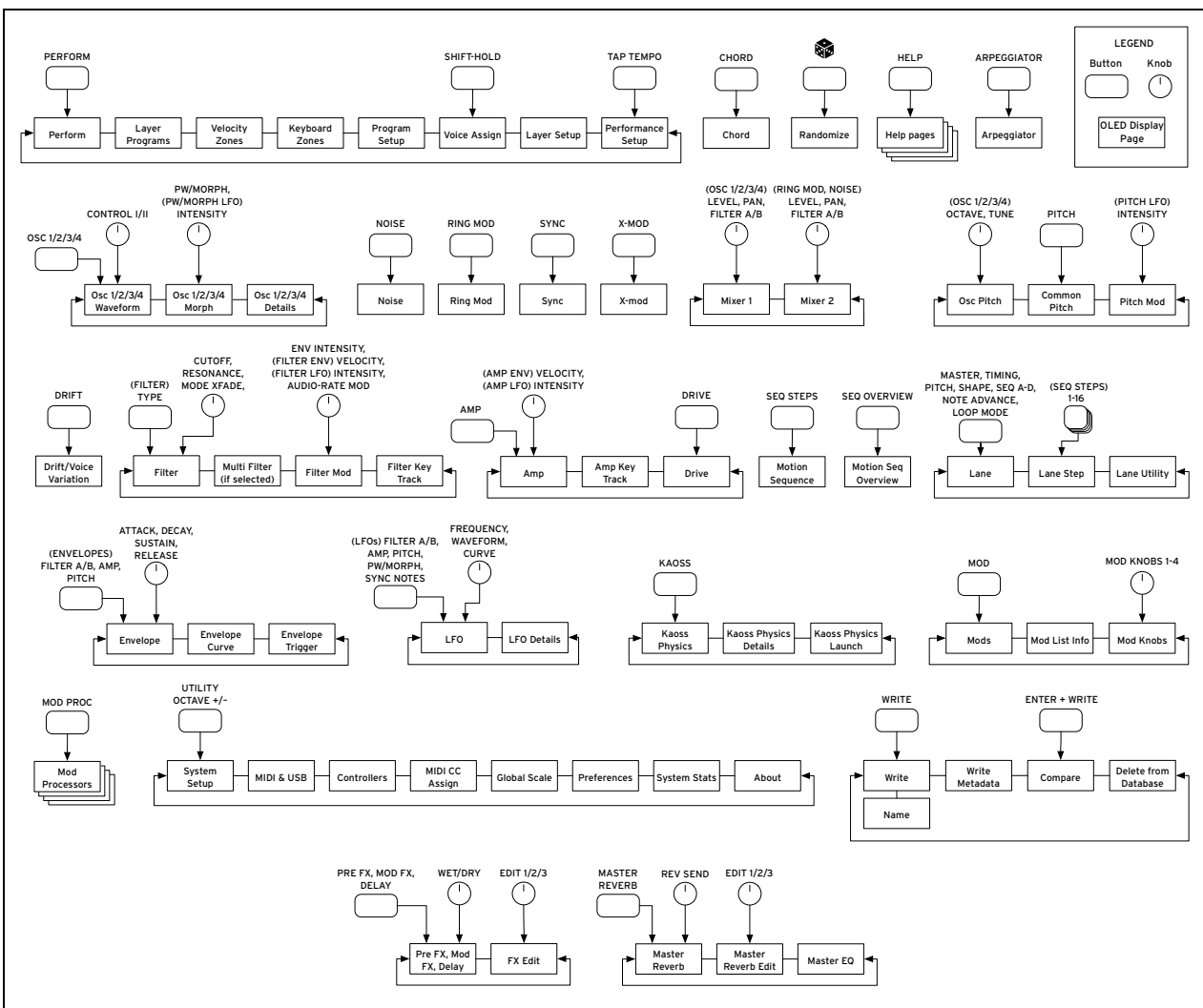

SHIFT

Hold down **SHIFT** to use alternative functions for knobs and buttons, labeled in blue text. For one-handed operation, double-press **SHIFT** to turn on Shift Hold; press again to turn off.

Double-press

To turn Layers, Oscillators, Kaoss Physics, Filters, and effects on and off, double-press their respective front-panel buttons. (You can also use **SHIFT**-press, if you prefer.) Similarly, you can use either double-press or **SHIFT** to select Banks for Set Lists and Motion Sequence Steps, as well as to select Motion Sequence Lanes.

ENTER for accelerated editing

Hold down **ENTER** to accelerate editing or scrolling. For example:

- Normally, the **VALUE** knob works as a “fine” value input when moved slowly, with “coarse” bigger jumps when moved quickly. To restrict it to “coarse” value changes, hold **ENTER** while turning **VALUE**.
- Hold **ENTER** and press **<** or **>** (or turn the **VALUE** dial) to scroll by a whole page in a list, such as when selecting Performances, Wavetables, or Mod routings.

Modulation

Most front-panel knobs and on-screen parameters are modulatable. Hold **MOD** and press **>** to create a new modulation routing. When viewing and editing modulations, hold **MOD** and press **<** to filter the list. See the Mod List Info page for an on-screen list of shortcuts.

Mod Knobs

You can use the Mod Knobs in real-time performance, and also save the results as new sounds. The names are shown on the main **PERFORM** screen. The values are stored, and can themselves be modulated. The Mod Knobs can control any number of parameters in any of the Layers.

Help pages

Hold **SHIFT** and press the  (Randomize) button to bring up a set of pages containing shortcuts and usage tips.

Structure

The multi/poly plays one Performance at a time.

A Performance has four Layers (A...D), Kaoss Physics, an Arpeggiator, and a master reverb and EQ.

Each Layer contains a Program, and other settings such as MIDI channel, key and velocity zones, etc.

A Program includes four oscillators, a noise generator, a ring modulator, dual filters, drive, and amp, plus a Motion Sequence, a set of modulators, a modulation matrix, a chord, and three effects: Pre FX, Mod FX, and Delay.

multi/poly structure

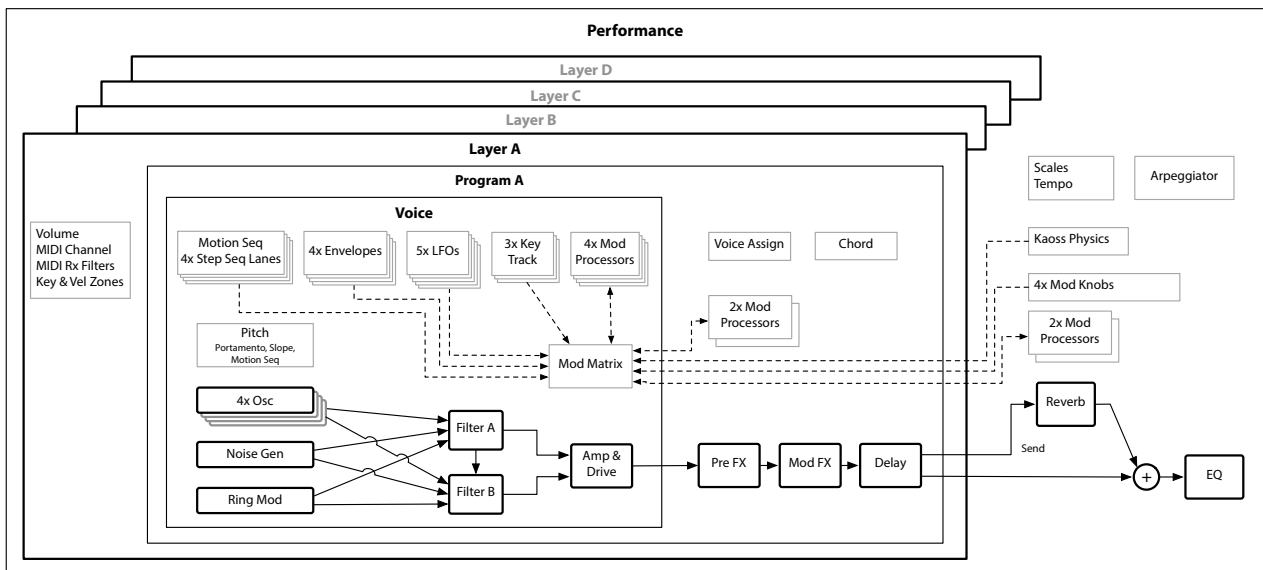

Selecting and Playing Sounds

Selecting Sounds

Selecting Performances from the display

1. Press the **PERFORM** button, and if necessary press it again.

Wherever you are in the system, the second press will always bring up the home page, with the large Performance name selected.

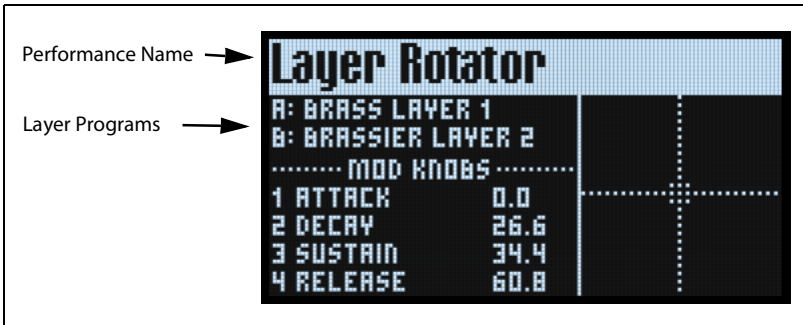

2. Follow the instructions under “Selecting from lists,” below.

Selecting from lists

Note: These instructions also apply to selecting Set Lists, Performances, Programs, Effects Presets, Motion Sequences, Wavetables, and Lane Presets.

1. Cursor to the item that you’d like to select.

For this example, we’ll use Performances, continuing from above.

2. Turn the **VALUE** knob or press **ENTER**.

A popup appears, showing a list of sounds.

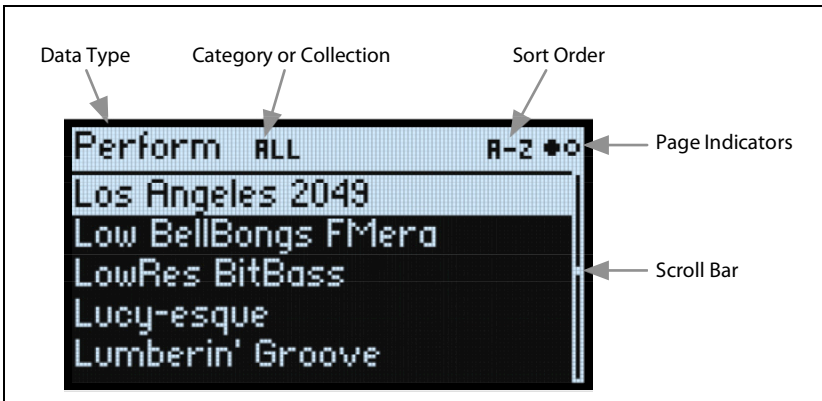

3. Turn the **VALUE** knob or use **<** and **>** to select sounds. Hold **ENTER** and press **<** or **>** to jump by 5.

You can play the sounds as you scroll through the list.

4. When you find a sound that you like, press **ENTER** again (or **SHIFT-ENTER** to cancel).

Using Categories

You can filter the list by category or collection. To do so:

1. While the list is onscreen, press **CATEGORY** buttons 2 (**BASS**) to 16 (**USER**) to show only a specific category of sounds.
2. To show all sounds again, press button 1 (**ALL**).

The category names on the front panel apply to Performances and Programs; for all other types of data (Wavetables, Motion Sequences, etc.), the buttons select the first 15 Categories in the list.

Selecting and Playing Sounds

You can also show the list of categories on the display. To do so:

1. In the list popup, hold **SHIFT** and press **>** (for **PAGE+**).

The Filters & Sort Order page appears.



2. Select the **Category** or **Collection** parameter, and turn the **VALUE** knob or press **ENTER**.

The Category or Collection Select popup appears. The lists will vary depending on the data type.

3. Select the desired **Category** or **Collection**, and press **ENTER**.

The display returns to the Performance Select popup, showing only sounds in the selected Category or Collection.

Using Sort Order

You can change the order in which sounds appear in the list. To do so:

1. In the list popup, press **PAGE+**.

The Filters & Sort Order page appears.

2. Select **Sort Order**, and turn the **VALUE** knob or press **ENTER**.

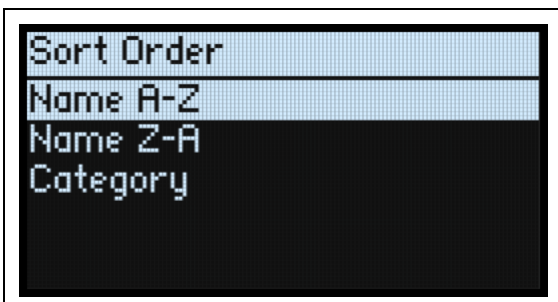

3. Choose the desired order.

You can choose from alphabetical (A-Z), reverse alphabetical (Z-A), or Category (sorted alphabetically within each Category).

Using Set Lists

Set Lists let you group and order Performances for gigs or projects. A Set List has 64 Slots, arranged into four banks A-D, corresponding to MIDI Program Change messages 1-64.

Important: Set Lists don't contain separate copies of their sounds; they just point to Performances stored in the database.

To select sounds in the current Set List:

1. Press the **SET LIST** button, so that it is lit.
2. To select sounds in the current bank, press buttons **1-16**.
3. To select from a different bank, first hold either **SHIFT** or **SET LIST** and then press **1/2/3/4** to select the bank. Buttons **1-16** will then blink; press one to select a sound in the new bank.

If you select a sound using the display, buttons **1-16** will go dark. To return to the Set List, just press one of the buttons again.

You can store many different Set Lists, and switch between them as desired. To select a different Set List:

1. Press **UTILITY** twice, to go to the System Setup page.



2. Select the Set List parameter, and press **ENTER** or turn the **VALUE** knob.

From this point, selecting Set Lists works just like selecting Performances, as described above.

Assigning a Performance to a Set List Slot

1. Select the Performance that you'd like to assign.
2. Press the **SET LIST** button, so that it is lit.
3. Hold **WRITE** and press the Slot to which you'd like to save.

The Write page appears, with that Slot already selected. To change the Slot, hold **WRITE** and press a different Slot button.

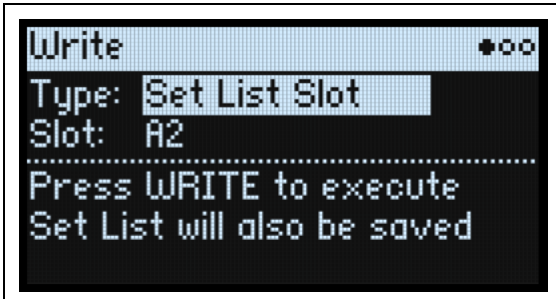

4. Press **WRITE**, and then **ENTER** to confirm.

The Set List will also be saved. If the Performance has been edited, you'll be prompted to save it too.

Assigning to a Slot in a different bank

While you're on the Write page, you can also select a Slot from a different bank (for instance, if you're copying a Performance to a different Slot):

1. Hold **WRITE** and **SHIFT** (or, if you prefer, **WRITE** and **SET LIST**), and press button **1-4** for the desired Bank.
2. Release **WRITE** and **SHIFT**.
3. Proceed to Step 3 above.

Saving Set Lists

To save the Set List:

1. Hold **WRITE** and press **SET LIST**.

The Write page appears, with the data type set to *Set List*.

2. To overwrite the existing Set List, press **WRITE**. To make a new copy and leave the existing Set List unchanged, press **SHIFT-WRITE**.
3. Press **ENTER** to confirm, or **SHIFT-ENTER** to cancel.

For more details, see "Saving Sounds" on page 14.

Basic Editing

Home Page (PERFORM)

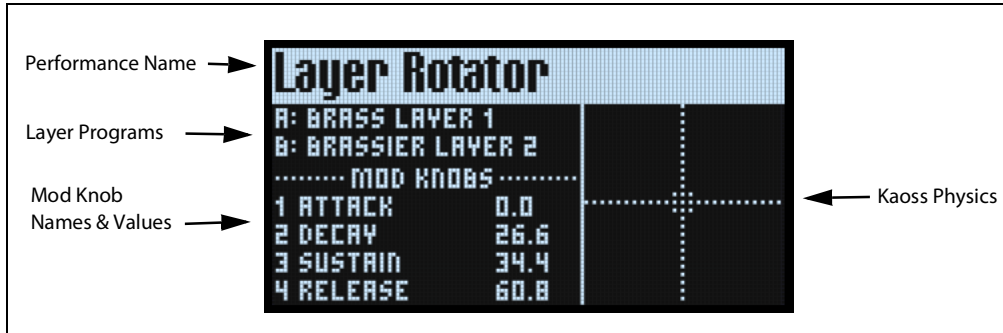

This is the multi/poly's main page, where you can select Performances, set the Programs for the four Layers, see the Mod Knob names and values, and view the Kaoss Physics graphic.

Wherever you are in the system, pressing **PERFORM** twice in row always returns here, with the Performance name selected.

Normally, using Mod Knobs takes you to the related pages in the display. The home page is an exception, so that you can use the Mod Knobs while browsing through Performances.

The home page is also the only one on which the Page Indicators do not appear. Press **PAGE+** to go to the Layer Programs page.

KAOSS Physics display

This shows the Kaoss Physics environment, which models a ball rolling on a surface. You can start the ball by flicking a finger on the x-y pad, or launch the ball automatically using a trigger source. You can also directly control the ball by holding your finger on the pad. The position of the ball produces several modulation signals, which can control any modulatable parameters. For more information, see “Kaoss Physics” on page 99.

Layer Programs

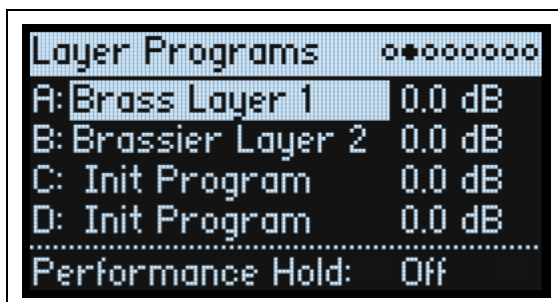

This page shows the Program selection and Volume for each Layer, as well as **Performance Hold**.

A/B/C/D (Programs A/B/C/D)

[List of Programs]

This selects the Program for the Layer.

(Volume A/B/C/D)

[-Inf, -84.9...+6.0 dB]

This controls the volume of the Layer (duplicating the Layer Setup page's **Volume** parameter). This is saved in the Performance, instead of the Program—so it's a good choice when balancing levels between Layers.

Performance Hold (HOLD)

[Off, On]

Use **Performance Hold** to hold notes or chords, leaving your hands free for knobs and modulation. This works differently from the Damper Pedal. When **Performance Hold** is *On*, notes or chords are held indefinitely until you play a new note or chord, at which point the previous notes are cut off and the new ones will sound.

Performance Hold applies only to Layers on the **Global MIDI Channel**.

Velocity Zones

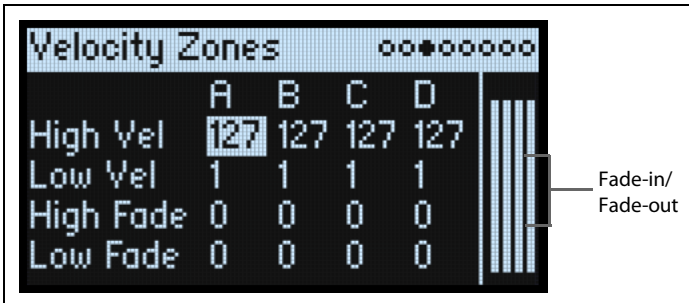

Shortcut: Pressing a **LAYER** button switches to the current parameter in the selected Layer's column.

High Vel (A/B/C/D), Low Vel (A/B/C/D)

[1...127]

These set the highest and lowest velocities on which the Layer will sound.

High Fade (A/B/C/D)

[0...126]

0: The **High Vel** acts as a hard split, with full volume on one side and silence on the other.

1...126: This lets you create a velocity crossfade. As velocity approaches the **High Vel**, the volume fades out gradually. **High Fade** sets the velocity range over which the fade-out occurs, working inwards from the **High Vel**.

Low Fade (A/B/C/D)

See "High Fade (A/B/C/D)," above.

Setting values from the keyboard

You can set velocities and note numbers directly from the keyboard, or via MIDI. This applies throughout the multi/poly. To do so:

1. Select the velocity or note number parameter you'd like to edit.
2. Press and hold the **ENTER** button.
3. Play a note on the keyboard to set the parameter.
4. Release the **ENTER** button.

Keyboard Zones

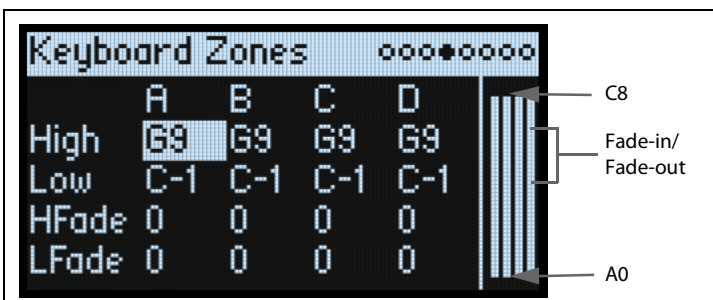

Basic Editing

Shortcut: Pressing a **LAYER** button switches to the current parameter in the selected Layer's column.

High (A/B/C/D), Low (A/B/C/D)

[C-1...G9]

These set the highest and lowest notes on which the Layer will sound.

Note: The graphic shows only the standard range of 88 notes.

HFade (High Fade A/B/C/D)

[0...127]

0: The **High** key acts as a hard split, with full volume on one side and silence on the other.

1...127: This allows you to create a keyboard crossfade. As the notes approach the **High** key, the volume will fade out gradually. This sets the number of semitones over which the fade-out occurs, working inwards from the **High** key.

LFade (Low Fade A/B/C/D)

[0...127]

See “HFade (High Fade A/B/C/D),” above.

Program Setup

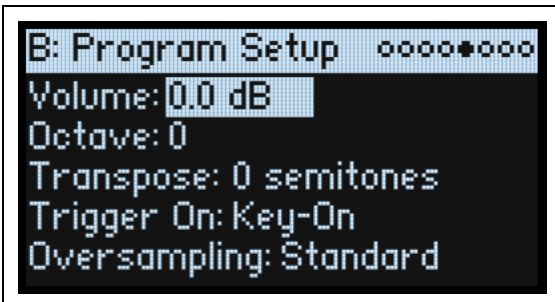

The settings on this page are stored with the Program, if the Program is written separately.

Volume

[-Inf, -84.9...0.0 dB]

This controls the overall volume of the Program. Unlike Layer Volume, it's stored with the Program. Use this to balance the Program's default volume with respect to other Programs.

Octave

[-4...+4]

This transposes the Program by up to four octaves up or down.

Transpose

[-12...+12 semitones]

This transposes the Program by up to one octave, up or down, in semitones.

Trigger On

[Key-On, Key-Off]

Key-On: This is the default setting, in which the Program is played when a key is pressed.

Key-Off: The Program will play as soon as you release the key. You can use this to create the “click” heard when a harpsichord note is released, for instance. In general, when using *Key-Off* it's also best to set the Amp Envelope **Sustain** to 0.

Oversampling

[Standard, Extreme]

Oversampling means that the internal algorithms run at higher than normal sample rates, for increased audio fidelity. The multi/poly always uses oversampling; it's just a question of how much.

Standard yields higher polyphony, and should sound fantastic for almost all sounds.

Basic Editing

Extreme cuts polyphony in half (or more), but can improve fidelity in a few specific situations, such as when playing high pitches with specific waveshaper setups. When we started working on the multi/poly, we thought that *Extreme* might be necessary more of the time, even though we had implemented a number of different anti-aliasing and other quality-enhancing techniques throughout the system. In the end, we found that *Extreme* only makes an audible difference in rare cases, and even then we sometimes aren't sure which version we prefer. Because of this, and because of its polyphony hit, we recommend only switching to *Extreme* for monophonic or low-polyphony sounds, and only then if you really hear a difference.

Voice Assign

Mode = Poly

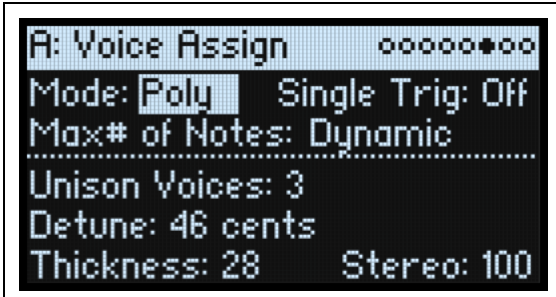

The settings on this page are stored with the Program, if the Program is written separately. You can jump to this page by pressing **SHIFT + HOLD**.

(Voice Assign) Mode

[Poly, Mono]

This selects the basic voice allocation mode. Depending on which one you select, various other options will appear, such as **Single Trig** (*Poly* mode only) and **Mono Legato** and **Priority** (*Mono* mode only).

Poly: The Program will play polyphonically, allowing you to play chords.

Mono: The Program will play monophonically, producing only one note at a time.

Single Trig (Single Trigger)

[Off, On]

Single Trigger is available when **Voice Assign Mode** is set to *Poly*.

On: When you play the same note repeatedly, the note's voice card will be reused; see "Virtual voice cards and drift" on page 57. Filter, envelope, and other states will be retained, just like on a vintage analog synth. This is the default.

Off: When you play the same note repeatedly, the notes will overlap.

Max # of Notes

[Dynamic, 1...8]

Max # of Notes is available when **Voice Assign Mode** is set to *Poly*.

Dynamic is the default. With this setting, you can play as many notes as the system allows.

1-8 limits the number of notes played by the Program. Voices will be allocated dynamically up to this maximum. You can use this to:

- Model the voice-leading of vintage synthesizers
- Control the resources required by individual Programs

This setting does not limit the **Unison Voices** parameter. For instance, if **Max # of Notes** is set to 6, and **Unison Voices** is set to 3, you can play up to 6 notes, each with 3 Unison voices.

Basic Editing

Mode = Mono



Legato

[Off, On]

Legato is available when **Voice Assign Mode** is set to *Mono*.

Legato means to play in a smooth, connected way; the next note is played before the last note is released.

On: The first note in a legato phrase will sound normally; subsequent notes in the phrase will sound smoother (for instance, envelopes will continue instead of restarting).

Off: Legato playing will produce the same sound as detached playing.

Priority

[Low, High, Last]

Priority is available when **Voice Assign Mode** is set to *Mono*.

This determines what happens when more than one note is being held down.

Low: The lowest note will sound. Many vintage monophonic analog synths work this way.

High: The highest note will sound.

Last: The most recently played note will sound.

Unison Voices

[1...16]

Unison can be used in both *Mono* and *Poly* modes.

1: Unison is off, and **Stereo Spread** and **Detune** do not apply.

2-16: The Program uses the specified number of stacked, detuned voices to create a thicker sound.

Detune

[0...200 cents]

This parameter sets the tuning spread for the **Unison** voices.

Voices = 3, Detune = 24, Thickness Off

Voices	Detune
1	-12
2	0
3	+12

Voices = 4, Detune = 24, Thickness Off

Voices	Detune
1	-12
2	-4
3	+4
4	+12

Thickness

[0...100]

This parameter controls the character of the detuning for the unison voices.

0: Unison voices are evenly distributed across the **Detune** range, as shown above.

1...100: Unison voices are detuned asymmetrically. This makes the detuning more complex, and changes the way in which the pitches beat against one another—like slightly out-of-tune oscillators in a vintage synthesizer. Higher numbers increase the effect.

Stereo (Spread)

[0...100]

Stereo lets you create a wider stereo field when using **Unison**. It applies only when **Unison Voices** is 2 or greater.

Layer Setup

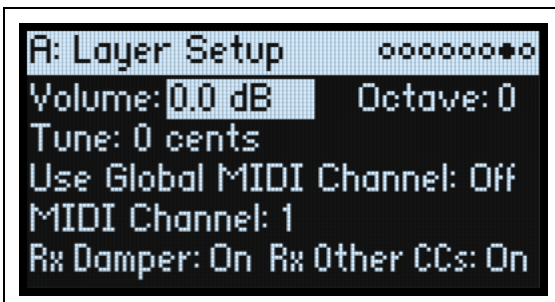

Volume

[-Inf, -84.9...+6.0 dB]

This controls the volume of the Layer. Note that this is saved in the Performance, but not with the Program—so it's a good choice when balancing levels between Layers.

Octave

[-3...+3]

This transposes the Layer by up to 3 octaves, up or down.

Tune

[-100...+100 cents]

This lets you detune the Layer by up to 100 cents (1/100 of a semitone), up or down.

Use Global MIDI Channel

[Off, On]

On: This is the default. The Layer will play from the built-in keyboard, and receive on the **Global Channel**.

Off: The Layer will receive on the channel specified below, and will not play from the built-in keyboard.

MIDI Channel

[1...16]

This is shown only if **Use Global MIDI Channel** is *Off*. It sets the channel on which the Layer will receive MIDI.

Rx Damper

[Off, On]

On: This is the default. The Layer will respond to the connected damper pedal and to MIDI CC#64.

Off: The Layer will ignore both the connected damper pedal and MIDI CC#64.

Rx Other CCs

[Off, On]

On: This is the default. The Layer will respond normally to MIDI CCs.

Off: The Layer will ignore all MIDI CCs (except for CC#64), as well as Aftertouch, Poly Aftertouch, and Pitch Bend.

Performance Setup

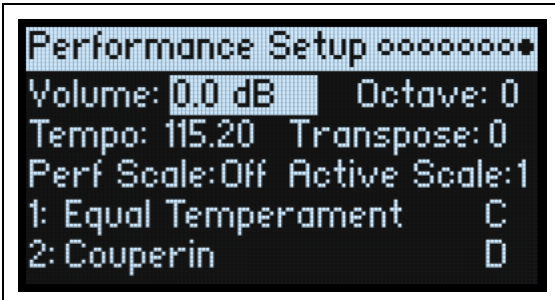

Volume

[*-Inf, -84.9...0.0 dB*]

This controls the Performance volume, for balancing levels with other sounds.

Octave

[*-2...+2*]

This transposes the entire Performance by up to 2 octaves, up or down.

Tempo (TAP TEMPO)

[*40.00...300.00*]

This sets the tempo for the Performance.

Transpose

[*-12...+12*]

This transposes the entire Performance by up to 12 semitones, up or down.

Perf Scale

[*Off, On*]

On: The Performance Scale settings, below, are used—unless **Global Scale** is *On*, in which case the Global scales are used instead.

Off: The Performance Scale settings are ignored.

Active Scale, 1 (Scale 1), (Key), 2 (Scale 2), (Key)

For details on the scale parameters, see “Global Scale” on page 121.

Write

Saving Sounds

The Performance, with its four Layers, contains a complete multi/poly sound. When selecting, editing, and saving sounds, Performances are all you need to use. While you can save Programs and presets for Motion Sequences, Motion Sequence Lanes, and Kaoss Physics, you don't have to do so: all data is contained in the Performance.

Similarly, when you load any of these other data types into a Performance, a new copy of the data is created in the Performance. Any edits affect only the local copy inside the Performance, and not the original data. This lets you edit freely without worrying about changing other sounds.

To save:

1. Press the **WRITE** button.

The Write page appears, with the type of data to write shown at the top of the page. By default, this is set to *Performance*.

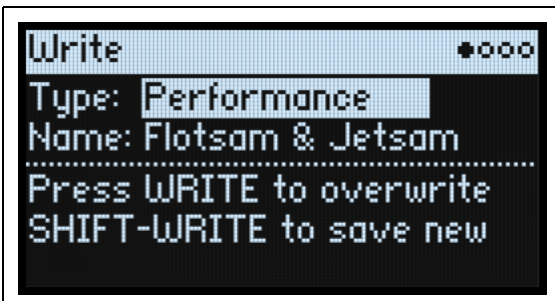

2. To choose a different data type, hold **WRITE** and press a button such as **LAYER A** or **SEQ STEPS**, or set the **Type** manually in the display.

For Programs, Motion Sequences, and Lanes, another parameter will appear: **From** (*Layer A...D*). For example, if **Type** is *Timing Lane*, and **From** is set to *Layer B*, Write will save the Timing Lane from Layer B. This defaults to the currently selected Layer, but you can change it if desired.

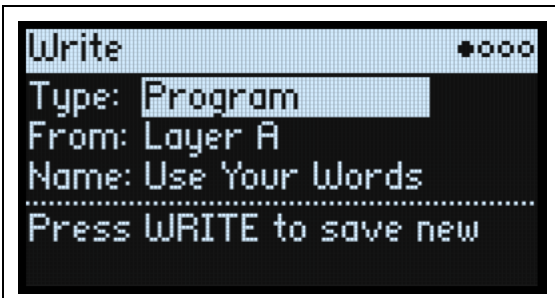

3. If necessary, set the **From** parameter to the desired Layer, either on-screen or by pressing one of the **LAYER** buttons.
4. Optionally, edit the name and/or Categories before proceeding.

For more details, see “Editing names” on page 15 and “Write Metadata” on page 15.

⚠ Important: changing the name does not automatically make a new copy of the sound!

5. To overwrite the existing sound, press **WRITE**. To make a new copy and leave the existing sound unchanged, press **SHIFT-WRITE**.
6. Press **ENTER** to confirm, or **SHIFT-ENTER** to cancel.

Factory sounds may be write-protected, in which case only “save new” is available.

⚠ Never turn off the power while data is being saved. Doing so may destroy the internal data.

Name

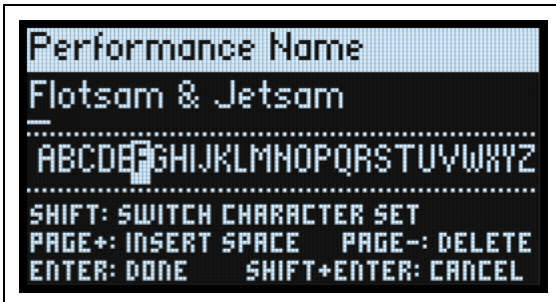

Note: you can name Programs, Motion Sequences, Lanes, and Kaoss Physics Presets without writing them separately. As long as you save the enclosing Performance, the new name will be saved.

Editing names

1. On the Write page, select the Name.
2. Press **ENTER**, or turn the **VALUE** dial.

The Name page appears.

3. Use the cursor buttons to move back and forth in the text, and use **VALUE** to select a character from the set shown below.

Names can be up to 24 characters long.

4. Press **SHIFT** to toggle between A-Z, a-z, numbers, and symbols.
5. Hold **SHIFT** and press **>** (**PAGE+**) to insert a space.
6. Hold **SHIFT** and press **<** (**PAGE-**) to delete the previous character.
7. When you've finished entering text, press **ENTER** to return to the previous page, or **SHIFT-ENTER** to cancel.

Write Metadata

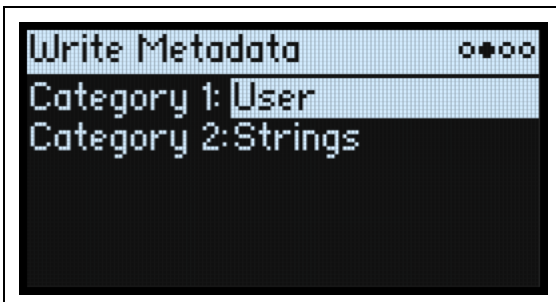

The second page under Write allows you to select two Categories for the saved item. When searching by Category, a sound will be shown if either of its Categories match the search criteria.

Note: When **Type** is set to *Set List Slot*, this page is not available.

Category 1/2

[List of Categories]

Each object type—Performances, Programs, etc.—has its own list of Categories. Note that only the first 15 Categories are mapped to the front-panel buttons.

Compare

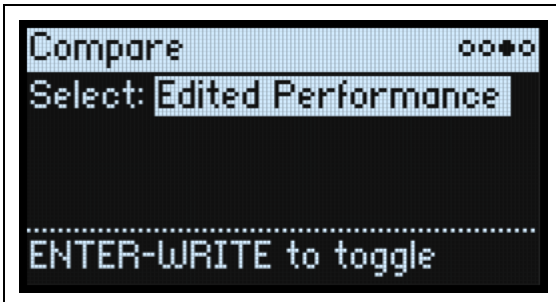

Select

[Saved Performance, Edited Performance]

Saved Performance: The saved version of the Performance will be heard.

Edited Performance: The edited version of the Performance will be heard. If the Performance has not been edited, this is not available.

Using Compare

To use compare:

1. Hold **ENTER** and press **WRITE**.

The Compare page will appear.

2. Hold **ENTER** and press **WRITE**, again, to toggle between the saved and edited versions of the Performance.

When you change from *Edited Performance* to *Saved Performance*, the edited version is stored in a buffer, and the Performance reverts to the version saved in the database. You can toggle back and forth between the two as many times as you like.

- ⚠ If you change to *Saved Performance* and then make any edits, the next time you go to the Compare page **Select** will be set to *Edited Performance*, and the previously buffered “Edited Performance” will be lost.

Delete from Database

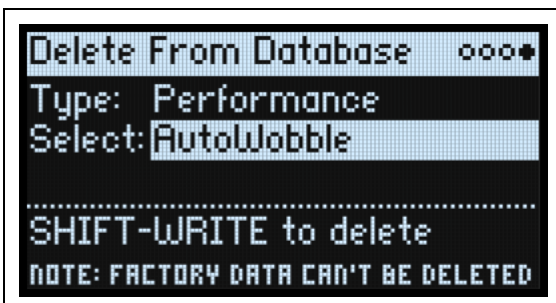

This page lets you delete user-created items from the database.

- ⚠ **Note:** Factory data cannot be deleted.

Using Delete

To delete an item from the database:

1. Set the Type as desired.
2. Cursor to **Select**, and press **ENTER**.

The selection popup appears.

3. Select a user-created item from the list. Optionally, use **PAGE+** to change the filters or sort order.
4. Press **ENTER** to confirm the selection and close the popup.
5. Hold **SHIFT** and press **WRITE** to delete the selected item.

Write

A confirmation dialog will appear.

6. Press **ENTER** to confirm, or any other key to cancel.

Oscillators

Oscillator 1/2/3/4

Overview

Programs have four identical oscillators, each capable of operating as classic analog oscillators, digital wavetable oscillators, or waveshaper oscillators; use these different types in any combination. In addition to the four oscillators, there's a noise generator and a ring modulator. Optionally, routing through filters, drive, and amp may be true stereo, with per-oscillator pan.

Oscillator Enable (**SHIFT-OSC 1/2/3/4**)

[Off, On]

Each Oscillator can be enabled or disabled. To do so, **SHIFT**-press or double-press the corresponding front-panel button: **OSC 1**, **OSC 2**, etc. Disabling Oscillators frees up processing power, and in some cases may yield higher polyphony. Note that if you're using an Oscillator for modulation purposes, including Sync, X-Mod, Ring Modulation, or audio-rate filter modulation, it must be enabled for the modulation to work.

Oscillator Type (**OSC TYPE**)

[Classic, Digital, Waveshaper]

This three-way switch controls the basic capabilities of the Oscillator.

Classic: The Oscillator plays classic analog synthesis waveforms. See “Classic Type: Osc 1/2/3/4 Waveform” on page 19.

Digital: The Oscillator plays a Wavetable with up to 64 individual waveforms. Modulate **Position** to sweep through the waveforms. **Wavetable Modifiers** change the way that the tables are generated at load time, resulting in subtle to extreme changes in timbre. **Morph Types** change the way that the Wavetables are played, and can be modulated in real-time from envelopes, LFOs, and so on. See “Digital Type: Osc 1/2/3/4 Waveform” on page 22.

Waveshaper: The Oscillator plays either a sine or triangle wave through a waveshaper, with a wide selection of waveshaper tables. Modulate **Gain** and **Offset** to create dynamic timbres. See “Waveshaper Type: Osc 1/2/3/4 Waveform” on page 27.

Front panel controls

OSC Type	Press OSC button	CONTROL I	CONTROL II	PW/MORPH
Classic	Waveform	Wave Blend	n/a	PW, Phase, Detune
Digital	Wavetable	Position	Wavetable Modifier	Morph
Waveshaper	Waveshaper table	Gain	Gain Offset	PW
Noise	Source (Patch, Voice)	Cutoff	n/a	Speckle
Ring Mod	Type	Modulator	n/a	Carrier

Classic Type: Osc 1/2/3/4 Waveform

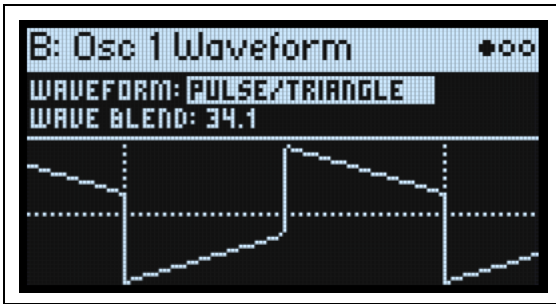

Waveform

[Saw, Pulse, Triangle, Saw/Pulse, Saw/Triangle, Pulse/Triangle, Square/Triangle, Double Saw, Detuned Saw 1, Detuned Saw 2, Shark Fin]

This selects the waveform for the oscillator, and also affects the assignments of the **CONTROL I** and **PW/MORPH** knobs, as described below. Press the **OSC 1/2/3/4** buttons to jump to this parameter.

Saw produces a sawtooth wave—the traditional buzzy analog synth sound.

Pulse produces a square wave with variable pulse width, controlled by **PW/Morph**.

Triangle produces a pure tone with relatively few overtones. **PW/Morph** controls the waveform’s symmetry, making it “lean” forwards and backwards.

Saw/Pulse creates both of the waveforms at the same time. **Wave Blend** crossfades between the two. **PW/Morph** controls the width of the Pulse wave.

Saw/Triangle simultaneously creates a sawtooth and a triangle wave. **Wave Blend** crossfades between the two. **PW/Morph** controls the symmetry of the triangle wave.

Pulse/Triangle simultaneously creates pulse and triangle waves. **Wave Blend** crossfades between the two. **PW/Morph** controls the width of the Pulse wave.

Square/Triangle simultaneously creates a square wave (in which the pulse width is fixed at 50%) and a triangle wave. **Wave Blend** crossfades between the two. **PW/Morph** controls the symmetry of the triangle wave.

Double Saw produces two sawtooth waveforms simultaneously. You can adjust the phase of the second sawtooth using the aptly-named Phase parameter, below, and adjust its volume with the **2nd Saw Level** parameter.

Detuned Saw 1 produces two detuned sawtooth waveforms simultaneously. **Detune** controls the amount of detuning, and **2nd Saw Level** adjusts the volume of the second sawtooth.

Detuned Saw 2 is similar to *Detuned Saw 1*, except that the second sawtooth is 180 degrees out of phase. This produces a timbre similar to pulse width modulation, with the **Detune** parameter controlling both detune and the speed of the PWM effect.

Shark Fin is a distinctive waveform shape from a classic American mono synth, combining aspects of triangle and sawtooth waves.

Wave Blend (CONTROL I)

[0.0...100.0]

Wave Blend is available when **Waveform** is set to *Saw/Pulse*, *Saw/Triangle*, *Pulse/Triangle*, or *Square/Triangle*. This control crossfades between the two waveforms. At 0, you’ll hear only the first waveform; at 100, you’ll hear only the second waveform; and at 50, you’ll hear an equal mix of both.

2nd Saw Level (CONTROL I)

[0.0...100.0]

2nd Saw Level is available when **Waveform** is set to *Double Saw*, *Detuned Saw 1*, or *Detuned Saw 2*. This controls the volume of the second Sawtooth wave.

Oscillators

Knob controls for each Waveform

Waveform	CONTROL I	PW/MORPH
Saw	n/a	n/a
Pulse	n/a	Pulse Width
Triangle	n/a	Triangle symmetry
Saw/Pulse	Xfade between saw & pulse	Pulse Width
Saw/Triangle	Xfade between saw & triangle	Triangle symmetry
Pulse/Triangle	Xfade between pulse & triangle	Pulse Width
Square/Triangle	Xfade between square & triangle	Triangle symmetry
Double Saw	Volume of 2nd saw	Phase
Detuned Saw 1	Volume of 2nd saw	Detune
Detuned Saw 2	Volume of 2nd saw	Detune/PWM effect
Shark Fin	n/a	n/a

Classic Type: Osc 1/2/3/4 Morph

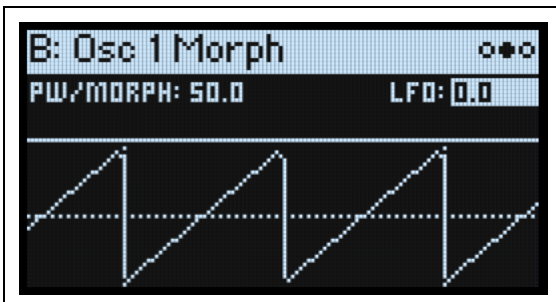

PW/Morph

[0.0...100.0]

PW/Morph is available when **Waveform** is set to *Pulse*, *Saw/Pulse*, *Triangle*, *Saw/Triangle*, *Pulse/Triangle*, *Square/Triangle*, or *Double Saw*.

When the **Waveform** is set to *Pulse*, *Saw/Pulse*, or *Pulse/Triangle*, this controls the width of the pulse waveform. For details, see “More on Pulse Width,” below.

When **Waveform** is set to *Triangle*, *Saw/Triangle*, or *Square/Triangle*, this controls the symmetry of the triangle waveform.

When **Waveform** is set to *Double Saw*, this controls the phase relationship between the two sawtooth waves.

LFO (LFO PW/Morph Intensity) (LFO INTENSITY)

[-100.0...+100.0]

This controls the amount of modulation of Pulse Width, Triangle symmetry, or Phase from the PWM/Morph LFO. The front-panel **LFO INTENSITY** knob controls the value for the selected Oscillator.

More on Pulse Width

Pulse waveforms are simple, rectangular shapes. **Pulse Width** sets the percentage of the waveform spent in the “up” position. A few examples are shown in the diagram below. Note that a square wave is just a pulse with the width set to 50.0.

The width controls the timbre of the oscillator, from pure and hollow at 50.0 to thin and reedy at the extremes.

At settings of 0.0 and 100.0—or when **Pulse Width** is modulated to these values—the pulse wave will be silent, since these eliminate the “pulse” altogether.

Oscillators

The real magic of the pulse wave comes when you modulate the width. Try using a medium-speed triangle LFO, or a sweeping envelope.

Pulse waveform at different widths

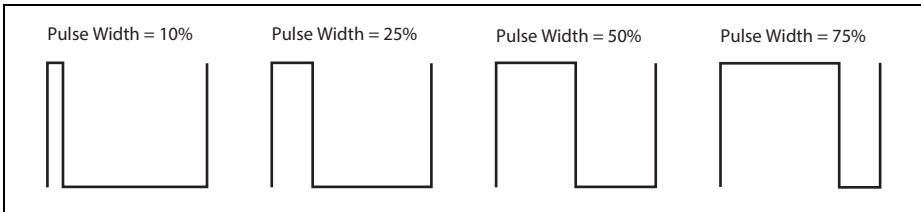

Morph - detune

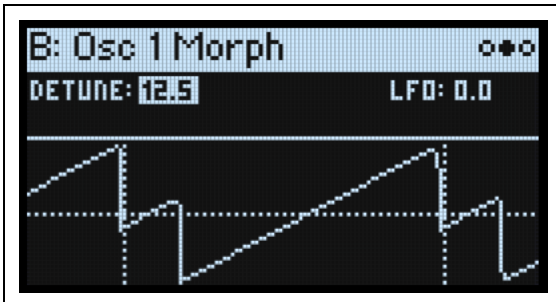

Detune

[0.0...25.0] (cents)

Detune is available when **Waveform** is set to *Detuned Saw 1* or *Detuned Saw 2*. This controls the amount of detuning between the two saws, in cents. Saw 1 is tuned up, and Saw 2 is tuned down, so that the tonal center is maintained.

LFO (LFO Detune Intensity)

[-25.0...+25.0]

This controls the amount of modulation of Detune from the PWM/Morph LFO.

Classic Type: Osc 1/2/3/4 Details



Pitch Env (Pitch Envelope Intensity) (PITCH ENV > OSC)

[-72.0...+72.0] (semitones)

This controls the amount of pitch modulation, in semitones, from the Pitch Envelope. It's particularly useful for setting up classic swept-sync timbres. When the Pitch Envelope is selected, the front-panel **PITCH ENV > OSC** knob (**SHIFT-VELOCITY**) controls the value for the selected Oscillator.

Digital Type: Osc 1/2/3/4 Waveform

OSC 1/2/3/4 selects the on-screen **Wavetable** parameter; use the main VALUE encoder to change the Wavetable. See “Wavetable,” below.

CONTROL I controls the Position within the Wavetable. See “Position” on page 24.

CONTROL II selects the Wavetable Modifier. See “Mod (Wavetable Modifier)” on page 23. Note that this can’t be modulated.

PW/MORPH controls Morph amount. See “Morph (Amount)” on page 25.

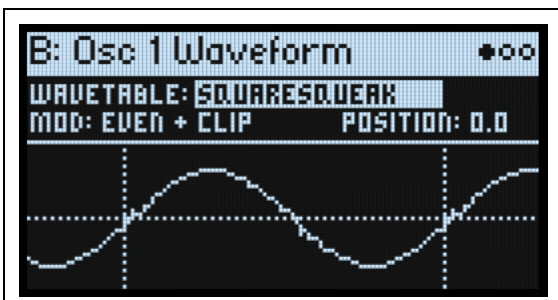

Wavetable

[List of Wavetables]

This selects the Wavetable. Select the parameter and then either turn the **VALUE** knob or press **ENTER** to bring up the Wavetable Select popup, which shows all of the Wavetables installed on the instrument. For details on sorting and filtering the list of Wavetables, see “Selecting from lists” on page 4.

The multi/poly ships with over 200 Wavetables, and you can also import your own using the Editor/Librarian application. For more information, see the Editor/Librarian manual.

Tip: Auditioning Wavetables

When auditioning Wavetables, play lower-pitched notes. The lower the pitch, the more clearly you’ll hear all of the high harmonics.

Most Wavetables are intended to be used with an envelope modulating **Position**. For the purposes of this tutorial, we’ll use the FILTER B Envelope. To set this up:

1. **Set Position to 0.0.**
2. **Press the envelope section’s FILTER B button, and then press SHIFT-> (PAGE +) to go to the Envelope Curve page.**
3. **Set the Preset to Linear.**
4. **Hold MOD and press >.**

The Add New Modulation popup appears.

5. **Move the CONTROL I knob to set the modulation destination.**
6. **Press the envelope section’s FILTER B button to set the modulation source to the Filter B Envelope.**
7. **Press ENTER to create the mod routing.**

The Mods page appears, showing the new routing.

8. **Set the Intensity to 100.0%.**

Adjust the amount of modulation as desired. Sometimes, you may want the intensity to be at its maximum; other times, especially with more complex Wavetables, much smaller amounts of modulation may be better.

Attack sweeps forward in the Wavetable, and **Decay** sweeps backwards; the **Sustain** level determines the resting point. Try both fast and slow envelope times for both **Attack** and **Decay**—even 10 or more seconds may be useful for particularly complex Wavetables!

Adjust both the **Position** and the amount of modulation as desired. Sometimes, you may want the intensity to be at its maximum; other times, especially with more complex Wavetables, much smaller amounts of modulation may be better.

Other Wavetables may be optimized for use with an LFO, to repeatedly sweep **Position** back and forth. For the purposes of this tutorial, we’ll use the FILTER B LFO. To set this up:

1. **Set Position to 50.0.**

Oscillators

2. Set the **FILTER B LFO** to use a **Triangle** wave.

3. Hold **MOD** and press **>**.

The Add New Modulation popup appears.

4. Move the **CONTROL I** knob to set the modulation destination.

5. Press the LFO section's **FILTER B** button to set the modulation source.

6. Press **ENTER** to create the mod routing.

The Mods page appears, showing the new routing.

7. Set the **Intensity** to **50.0%**.

Mod (Wavetable Modifier)

[None... Gain -6 dB]

Each waveform in a Wavetable is stored as a single 32-bit floating-point table with 2048 samples, referred to below as the "base table." This corresponds to a pitch of about 25 Hz. Tables for higher pitches are generated when the Wavetable is loaded. The Wavetable Modifier options let you change how these tables are generated, creating different-sounding variations of the stored data.

None: The Wavetable is loaded without alteration.

Odd Only: This preserves only the odd harmonics. All even harmonics (2, 4, 6, etc.) are removed.

Even Only: This preserves the fundamental and all the even harmonics. All odd harmonics (3,5,7, etc.) are removed. The result can sound like a sine wave at the fundamental plus a waveform an octave above that.

Skip Every 3: This removes every third harmonic (3, 6, 9, etc.).

Odd + Clip: This combines *Odd Only* and *Hard Clip*, producing a brighter version of the Wavetable with increased overtones and only odd harmonics.

Even + Clip: This combines *Even Only* and *Hard Clip*, producing a brighter version of the Wavetable with increased overtones with only even harmonics.

Skip + Clip: This combines *Skip Every 3* and *Hard Clip*, producing a brighter version of the Wavetable with increased overtones and with every third harmonic removed.

Low 20: This removes all but the lowest 20 harmonics.

Low 12: This removes all but the lowest 12 harmonics.

Organ-ize: This emphasizes the harmonics that correspond to organ drawbars: 1 (8'), 2 (4'), 3 (2 2/3'), 4 (2'), 5 (1 3/5'), 6 (1 1/3'), and 8 (1'). The other harmonics are still present, but greatly reduced. The result is drawbar organ sounds with "stops" based on the Wavetable.

Vintage 8: This quantizes to 8 bits and disables band-limiting for all but the highest notes, resulting in a brighter sound with higher noise and significant aliasing.

Vintage 12: This quantizes to 12 bits and disables band-limiting for all but the highest notes, resulting in a brighter sound with moderate amounts of noise and aliasing.

4 Steps: Quantizes the base table to 2 bits, using band-limiting to minimize aliasing (so, you'll notice that the displayed waveform is smoother than a simple 2-bit waveform).

8 Steps: Quantizes the waveform to 3 bits, similar to *4 Steps*, above.

16 Steps: Quantizes the waveform to 4 bits, similar to *4 Steps*, above.

Soft Clip: Applies gentle soft clipping to the base table, adding overtones and increasing brightness.

Hard Clip: Applies a gain of 3.0 and then clips the result, for a greater increase in overtones and brightness.

Infinite Clip: Applies a ridiculous amount of gain, then clips the result.

Note that *Soft Clip*, *Hard Clip*, and *Infinite Clip* are very different from applying clipping to the audio output. The timbre isn't affected by the oscillator level or the number of voices being played, and the results are band-limited to avoid harsh tones.

Tilt Up: This reduces the levels of lower harmonics, and increases the levels of higher harmonics, tilted around the 12th harmonic.

Tilt Up +: Similar to Tilt Up, but more extreme.

Tilt Down: This increases the levels of lower harmonics, and reduces the levels of higher harmonics, tilted around the 12th harmonic.

Tilt Down +: This increases the levels of lower harmonics, and reduces the levels of higher harmonics, tilted around the 8th harmonic.

Oscillators

Low Boost: Boosts the first 5 harmonics.

Low Cut: Reduces the fundamental and first few harmonics.

Low Cut +: Reduces the first 5 harmonics.

Muted: Dramatically lowers the level of all harmonics above the fundamental.

Fade Out: Crossfades successive waves in the Wavetable with 0 so that the waveform fades to silence as Position increases. Use this to create decaying plucked or percussive sounds just by sweeping the Position.

Reverse: Loads the Wavetable's individual waves in reverse order. This is particularly useful for Wavetables which sweep from a bright or complex sound on one end to a dark or simple sound on the other.

Gain +3 dB, Gain +6 dB, Gain -3 dB, Gain -6 dB: Increase or decrease gain by the specified amounts.

Position

[0.0...100.0]

Wavetables contain up to 64 waveforms. **Position** sweeps through all of the waveforms in the Wavetable. *0.0* always selects the first waveform, and *100.0* selects the last waveform. The range between these extremes is divided between the total number of waveforms in the selected Wavetable, as shown below. For instance, if Wavetable A has four waveforms and Wavetable B has 23 (see the graphic below), a **Position** just under *50.0* will play waveform 2 in A, and waveform 12 in B.

Position

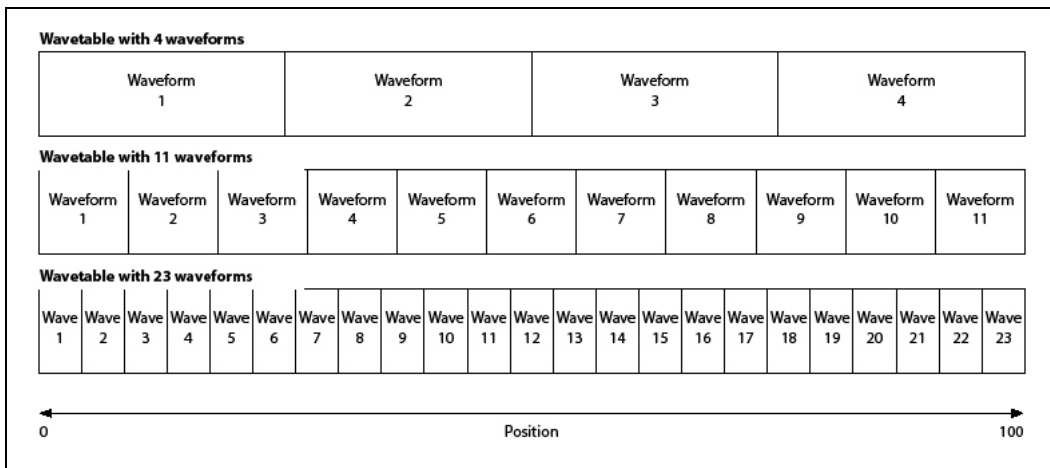

Digital Type: Osc 1/2/3/4 Morph

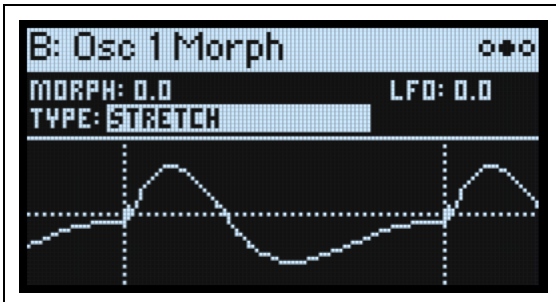

Morph (Morph Type)

[None, Stretch, Flip, Mirror, Mirror Stretch, Narrow, Narrow Stretch, W. NarrowStretch]

The **Morph Types** let you stretch, squeeze, reflect, and otherwise alter the Wavetables in real-time, changing their timbre and—when modulated—creating additional motion in the sound.

None: The Wavetable is played unaltered.

Stretch: The waveform is stretched in one direction and squeezed in the other, creating an effect similar to Pulse Width Modulation. When Morph Amount is set to *50.0*, the waveform is unaltered.

Flip: This inverts the polarity of a section of the waveform, with the “flip” point determined by Morph Amount.

Mirror: Shrinks the waveform to half its length, and then reflects that half-length waveform around the center as a mirror image. Morph Amount stretches and squeezes the waveform similar to Stretch, above.

Mirror Stretch: This is similar to Mirror, above, but doubles the Stretch effect.

Narrow: As Morph Amount increases, the waveform is compressed towards the front, with zeros filling the rest of the duty cycle. The effect is different from Stretch, but also has some similarities to Pulse Width Modulation.

Narrow Stretch: This combines Narrow and Stretch, compressing the waveform’s length while also stretching and squeezing.

Windowed Narrow: Similar to Narrow above, but with reduced high frequencies for lower aliasing.

W.NarrowStretch: Similar to Narrow Stretch above, but with reduced high frequencies for lower aliasing.

Morph (Amount)

[0.0...100.0]

This controls the intensity of the **Morph** process, as described above.

LFO (Intensity)

[-100.0...+100.0]

This sets the intensity of the **Morph** modulation from the PWM/Morph LFO.

Digital Type: Osc 1/2/3/4 Details



Xfade Width (Crossfade Width)

[0...100]

As the **Position** changes, the Wavetable changes from one waveform to another. When changing between two adjacent waveforms, the transition can be gradual or immediate. **Xfade Width** controls the amount of the **Position** range spent interpolating between neighboring waveforms vs. the amount playing single waveforms.

It may be helpful to think of the **Position** value range 0-100 as a ribbon, with the Wavetable stretched to fit, regardless of how many waveforms it contains. Each waveform is a stripe on the ribbon. **Xfade Width** controls the amount of blurring between the stripes. A given value for **Position** will always yield the same output, which will be either a solid stripe or some amount of blurring between two stripes. When **Position** changes continuously, as with an envelope or LFO, this causes crossfades between the waveforms.

Xfade Width

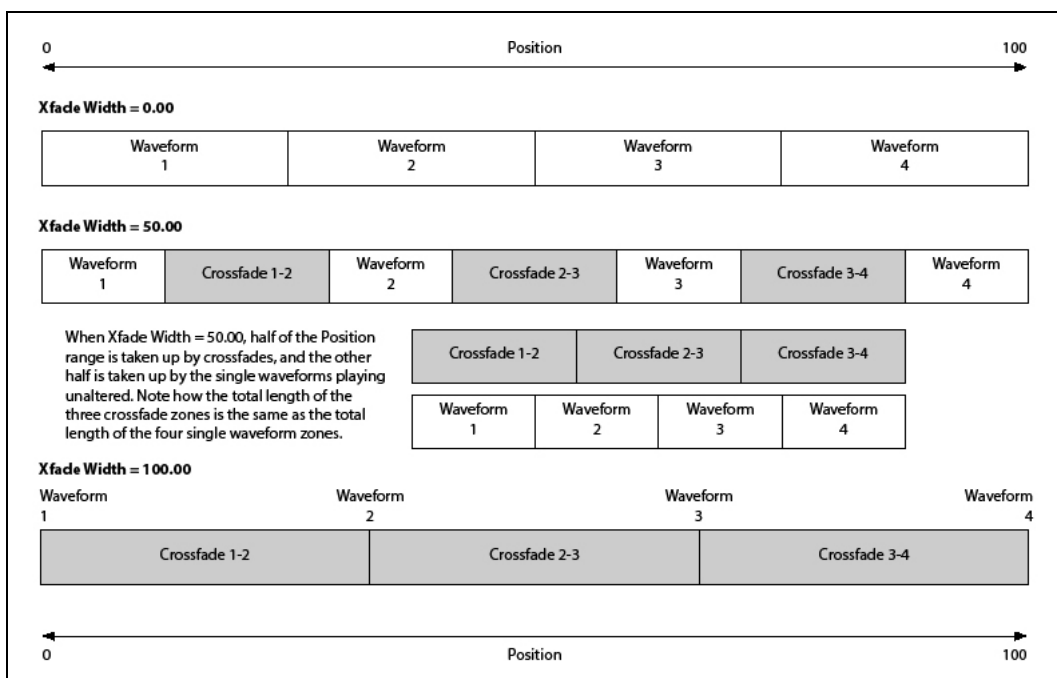

Waveshaper Type: Osc 1/2/3/4 Waveform

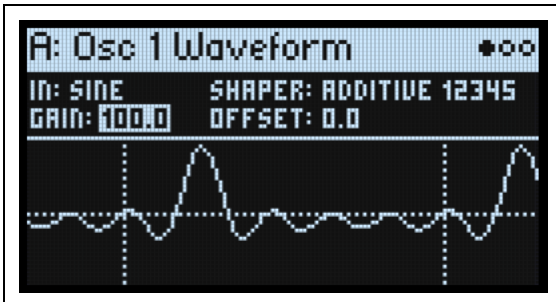

This is a west-coast style waveshaper/“wavefolder” oscillator, with some special twists. A sine or triangle wave goes into a Waveshaper, with a wide selection of tables.

CONTROL I sets the **Gain** into the table.

CONTROL II sets the **Offset**.

PW/MORPH controls the **Pulse Width** of the input oscillator.

In (Input)

[Sine, Triangle]

This selects the waveform which is then processed by the waveshaper table selected below. The descriptions of resulting sounds for the various tables are all based on a sine input; using triangle instead will generally create brighter sounds.

Shaper (Waveshaper Table)

[List of tables]

This selects the table used by the waveshaper. The waveshaping effect will be a combination of the input signal (sine or triangle), the selected table, and the settings for **Gain** and **Offset**.

Triangle and Square

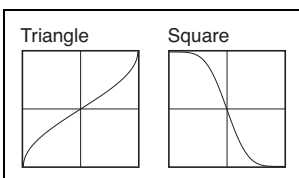

Triangle: With full-scale sine input, this table creates a triangle waveform. If you just want to create a triangle waveform, the *Classic* and *Digital* oscillators may sound a little better, but this table allows you to use **Gain** and **Offset** in creative ways. For more mellow, sine-like tones, reduce the **Gain**; for sharper timbres, increase it.

Square: This table creates soft clipping; the higher the **Gain**, the more clipping occurs. At maximum **Gain** the output is something like a soft square wave, with **Offset** being similar to pulse width.

Sines

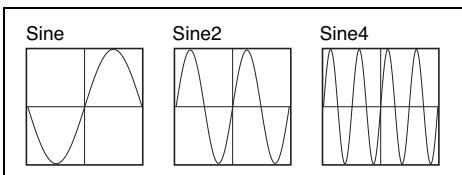

With sine wave input, these tables produce output similar to a simple FM pair with the Carrier:Modulator ratio set to 0:1. **Gain** functions like the FM input level, and responds well to modulation.

The tables differ only in their maximum brightness. Sine4 is the brightest, for the broadest range of timbres. Sine2 is darker, and Sine is darker still; these offer finer control with **Gain** modulation, for more subtle coloration.

Sine4: When **Gain** is at 100.0, this table is like 0:1 FM with the carrier level at maximum. To produce a similar effect to **Sine2**, reduce the **Gain** to 75.0; to produce a similar effect to **Sine**, reduce the **Gain** to 50.0.

Sine and Sine2: These are darker versions of **Sine4**.

Oscillators

Pickups

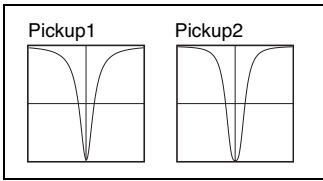

These tables simulate electromagnetic pickups, such as those of an electric piano.

To create electric piano sounds, use a sine wave as input, and assign an EG to modulate **Gain**; it should be around maximum at first, and then decay exponentially to a very low value. **Offset** controls the distance between the pickup and the center of the tine; typically, values close to 0 will work well.

Pickup1: This simulates a bright electromagnetic pickup.

Pickup2: This creates a different amount of saturation; its tone is slightly darker than *Pickup1*.

Tanh

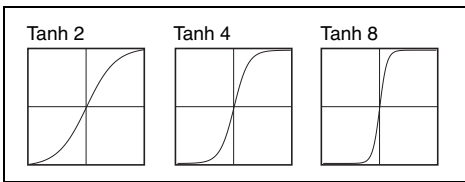

Tanh2, 4, and 8: These create soft clipping, similar to the Step. Vary the **Gain** to control the amount of distortion. 2, 4, and 8 produce increasing amounts of clipping. Maximum **Gain** will produce output similar to a soft-edged square wave.

Additive

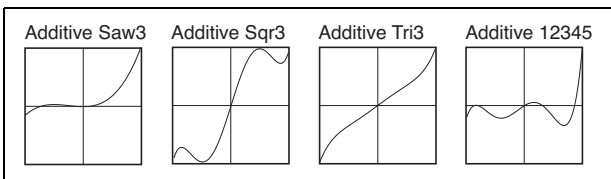

While the Additive tables can produce interesting results with any input signal, they produce the described results only with Sine input and maximum **Gain**. Reducing the **Gain** will diminish the level of the additive harmonics, making the result sound more like the original sine. Dynamic modulation of **Gain** may sound similar to a filter opening and closing.

Additive Saw3: This produces the first three harmonics of a sawtooth.

Additive Sqr3: This produces the first three harmonics of a square wave.

Additive Tri3: This produces the first three harmonics of a triangle wave.

Additive 12345: This produces harmonics 1 through 5 with equal amplitude, similar to a filtered pulse waveform.

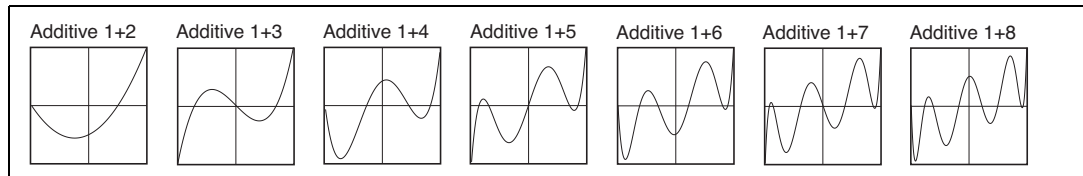

The “*Additive 1+*” group all produce the fundamental and an additional harmonic at equal amplitude.

Additive 1+2: This adds the 2nd harmonic, and sounds like an 8' + 4' organ stop.

Additive 1+3: This adds the 3rd harmonic, and sounds like an 8' + 2 2/3' organ stop.

Additive 1+4: This adds the 4th harmonic, and sounds like an 8' + 2' organ stop.

Additive 1+5: This adds the 5th harmonic, and sounds like an 8' + 1 3/5' organ stop.

Additive 1+6: This adds the 6th harmonic, and sounds like an 8' + 1 1/3' organ stop.

Additive 1+7: This adds the 7th harmonic.

Additive 1+8: This adds the 8th harmonic, and sounds like an 8' + 1' organ stop.

Oscillators

Multipliers

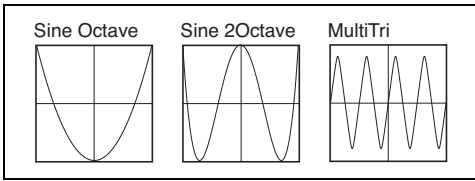

Sine Octave: With maximum **Gain**, this produces a sine wave one octave higher than the input.

Sine 2Octave: With maximum **Gain**, this produces a sine wave two octaves higher than the input signal. With decreasing **Gain** settings, it jumps down to the original octave—producing an interesting effect when **Gain** is modulated.

MultiTri: This is similar to *Sine4*, except that it uses a triangle shape. It produces output similar to a simple FM pair with the Carrier:Modulator ratio set to 0:1, and the carrier set to a triangle wave. **Gain** functions like the FM input level, and responds well to modulation.

TX Waves

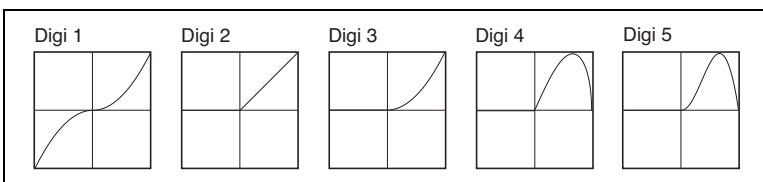

Digi 1 through 5: With maximum **Gain**, these produce waveforms similar to those of classic 4-operator FM synths (original TX waveforms 2, 3, 4, 7, and 8, respectively). Reduce **Gain** for a more sine-like sound.

Tube and Diode

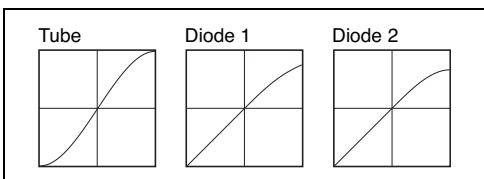

Tube: This is a soft-clipping table, for simulating analog saturation. **Gain** controls the amount of clipping; **Offset** controls symmetry, like DC offset into a VCA.

Diode 1 and 2: These produce asymmetric soft-clipping, like an analog diode. *Diode 2* produces more distortion than *Diode 1*.

Mixture

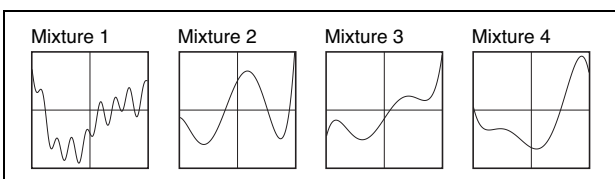

Mixture 1, 2, 3, and 4: With sine wave input, these four tables create a bunch of different harmonics at different amplitudes, like FM or organ stops.

Fuzzy

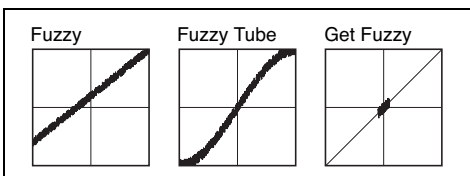

Fuzzy: This table adds random-sounding noise to the input, even with low input levels. Modulating **Gain** can produce interesting, grungy effects.

Fuzzy Tube: This is similar to *Fuzzy*, above, with the addition of soft clipping.

Oscillators

Get Fuzzy: This unusual table is noisy only around zero. High **Gain** settings will produce less noisy output, while low-level signals will be much more noisy.

01/W and Waveshaper Effect tables

The rest of the tables, save one, are based on those of the classic Korg 01/W and the Waveshaper effect.

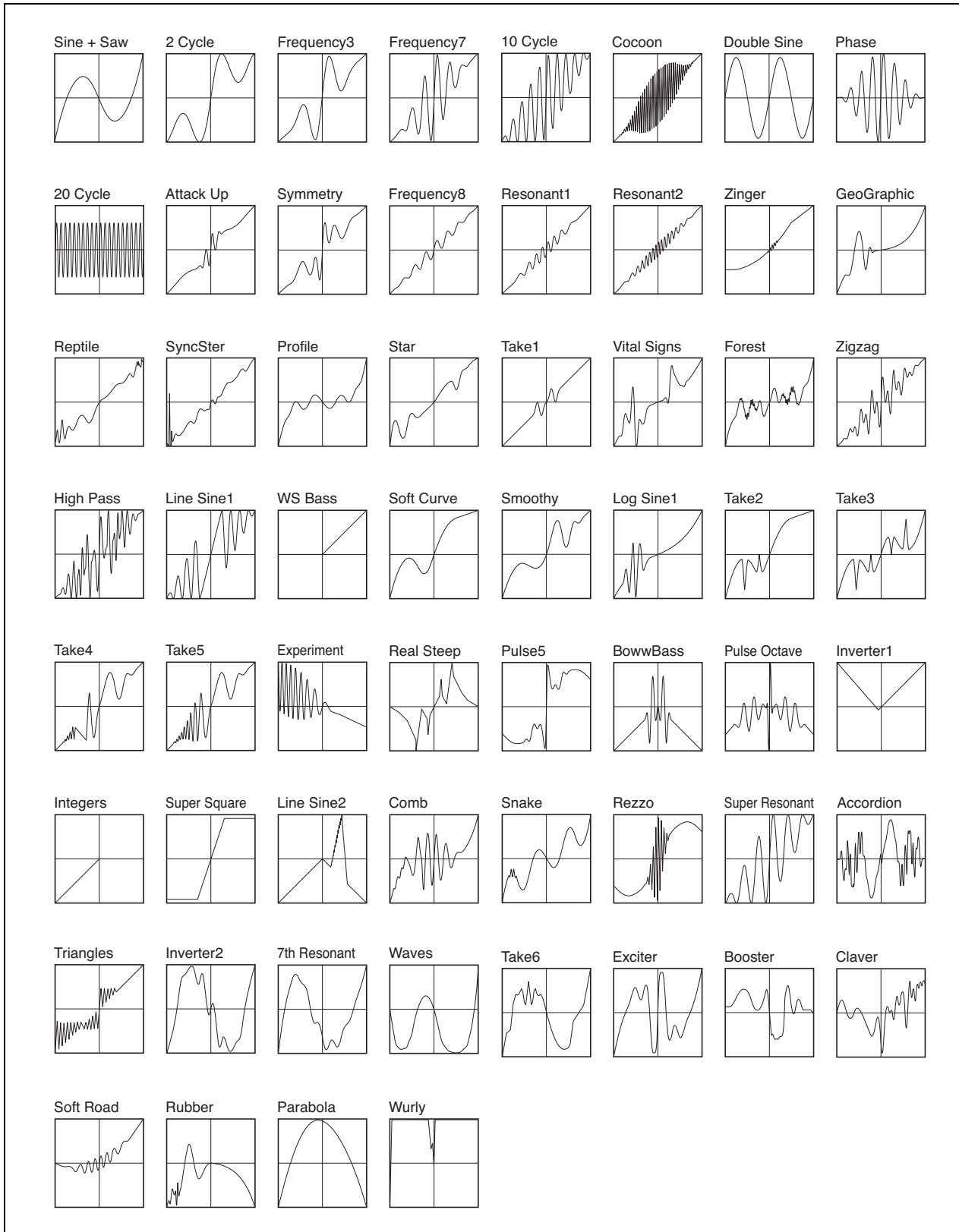

Oscillators

Berkeley

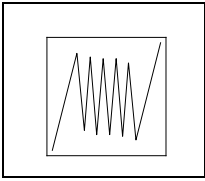

Berkeley: This is the classic “folder” waveshaper.

Gain

[-100.0...+100.0]

This sets the volume of the signal going into waveshaper. By reducing the **Gain**, you can make the signal interact with only part of the table. This is particularly useful in combination with **Offset**, as shown in the diagram below. **Gain** can also be modulated to create changes in timbre.

Gain and Offset

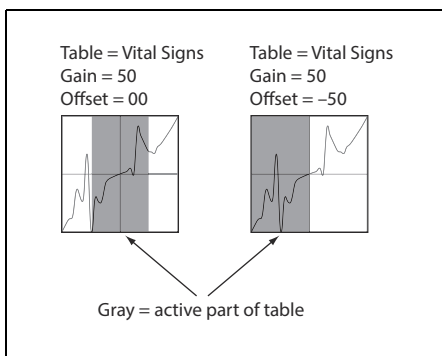

Offset

[0.0...100.0]

This introduces a DC Offset into the input signal, shifting the signal in relation to the waveshaper table.

With a full-scale input signal, this will make the signal clip on one side or the other, and result in an asymmetric waveform. When used in conjunction with **Gain**, it can select the part of the table used to process the signal. **Offset** can be modulated at note-on, which works well with sources such as *Velocity* and *Exponential Velocity*.

Offset also has specific uses with particular tables; see the individual table descriptions for more information.

For more information, see the diagram “Gain and Offset,” above.

Waveshaper Type: Osc 1/2/3/4 Morph

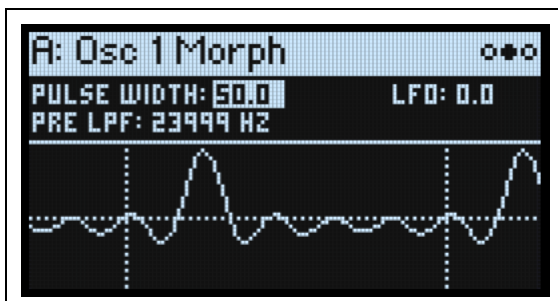

Pulse Width

[0.0...100.0]

This controls the pulse width, or symmetry, of the input waveform (Sine or Triangle). *50.0* is the unaltered input waveform. Below *50.0*, the first half of the input waveform’s duty cycle is increasingly compressed, and the second half is elongated. Values above *50.0* have the opposite effect: the first half of the waveform’s duty cycle is increasingly elongated, and the second half is compressed. When processed through the waveshaper, the resulting waveform is

Oscillators

stretched and compressed in the same way. When modulated (as from an LFO, below), the audible result is similar to pulse width modulation on an analog oscillator.

Pulse Width and Waveshaper output

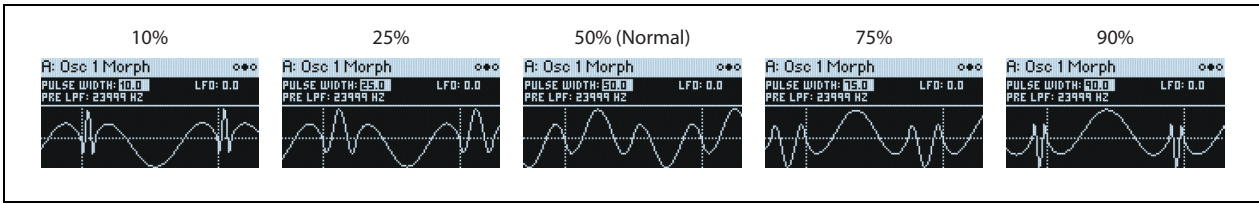

LFO (INTENSITY)

[-100.0...+100.0]

This controls the amount of Pulse Width modulation from the PW/MORPH LFO.

Pre LPF

[1,000...23,999 Hz]

This is the cutoff frequency of a simple lowpass filter for the **Input** signal. The filter acts on the **Input** before it enters the waveshaper, and its effect varies depending on the **Shaper** setting. For consistent timbre across the keyboard when using lower cutoff frequencies, modulate **Pre LPF** via keyboard tracking or note number.

Waveshaper Type: Osc 1/2/3/4 Details



This page is identical to that of the Classic Type; see “Classic Type: Osc 1/2/3/4 Details” on page 21.

Noise Generator

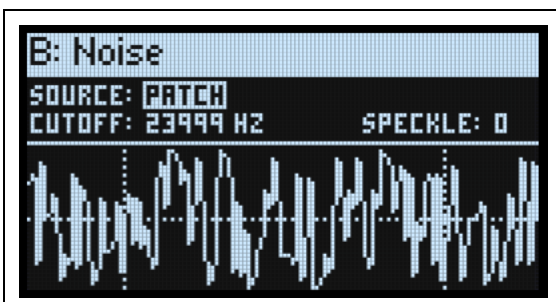

The noise generator includes **Speckle**, for creating unique and chaotic noise effects, and a dedicated 1-pole filter to control noise color.

For standard white noise, set **Speckle** to 0, and **Cutoff** to 23999.

For colored noise (such as pink noise), set **Speckle** to 0, and reduce **Cutoff** as desired.

To create “speckled noise” such as rocket sounds and thunder, set **Speckle** to 100, and **Cutoff** to a low value.

Oscillators

Noise Generator Enable (SHIFT-NOISE)

[Off, On]

To turn the Noise Generator on and off, **SHIFT**-press or double-press the front-panel **NOISE** button. Unlike similar controls for the Oscillators and Ring Modulator, this merely mutes the Noise Generator's output to the Mixer; the Noise Generator continues to run, and is always available for use in the Ring Modulator, X-Mod, and audio-rate filter modulation.

Source

[Patch, Voice]

This controls whether all the voices in the Program share a single noise generator, or if each voice has its own independent noise generator. Note that regardless of this setting, **Cutoff**, **Speckle**, and all mixer parameters are controlled per-voice.

Patch: This models the way that most analog synths worked. When two or more voices play simultaneously, the noise will be louder, and the noise's high frequency content will be unchanged.

Voice: Some digital synths use this approach. When two or more voices play simultaneously, the noise will not be as loud as with *Patch*, and phase cancellation affects the noise's high frequency content.

Cutoff

[20...23999 Hz]

This 1-pole lowpass filter controls the "color" of the noise.

Speckle

[0...100]

This control clips the noise signal, for added crunch. Subtle variations in **Speckle** are more noticeable with very low **Cutoff** settings, allowing you to create organic, rumbling timbres.

Ring Modulator



Ring Modulation modulates the volume of one signal (the Carrier) with another (the Modulator). When the frequencies of the Carrier and the Modulator are the same, the Ring Modulator produces steady, constant waveforms. When the two are detuned, it produces more movement and overtones.

Oscillators

Ring Modulation

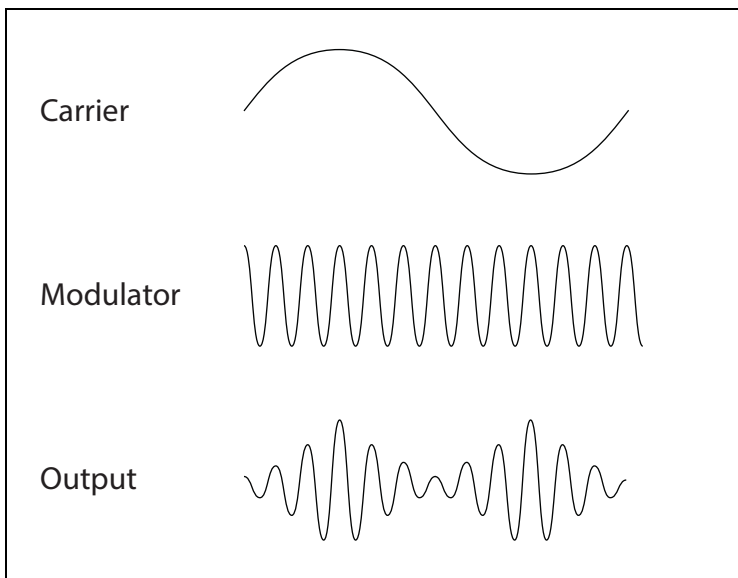

Ring Mod Enable (**SHIFT-RING MOD**)

[Off, On]

To turn the Ring Modulator on and off, **SHIFT**-press or double-press the front-panel **RING MOD** button. Disabling the Ring Modulator frees up processing power, and in some cases may yield higher polyphony. Note that if you're using the Ring Modulator for audio-rate filter modulation, it must be enabled for the modulation to work.

Carrier

[Osc 1...Osc 4]

This selects the oscillator for the Carrier input.

Modulator

[Osc 1...Osc 4]

This selects the oscillator for the Modulator input.

Osc/Noise (Modulator Oscillator/Noise Balance)

[Osc, 0.1...99.9, Noise]

You can blend the Noise Generator into the Modulator, for more chaotic effects. This controls the relative levels of the selected Oscillator and the Noise Generator.

Sync

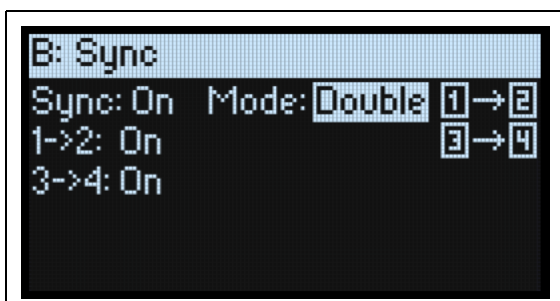

When Sync is On, the sync leader (e.g. Oscillator 1) controls the pitch of the sync follower(s) (e.g. Oscillator 2). Every time that the sync leader begins a new cycle—the instant that it passes through zero going from negative to positive—the sync follower snaps back to the start of its waveform. Changing or modulating the follower's frequency changes its timbre, instead of its pitch.

Oscillators

The multi/poly provides various options for sync between the four oscillators, as described below. The *Single* mode, in particular, lets you create unique sounds with Oscillators 2, 3, and 4 simultaneously following Oscillator 1; see “Tip: 3-oscillator sweep” on page 35.

Sync (SYNC)

[Off, On]

On: Sync is enabled, according to the parameters described below.

Off: Sync is disabled.

Mode

[Single, Double]

Single: Oscillator 1 is the sync leader, and Oscillators 2, 3, and 4 are the followers.

Double: The oscillators are grouped into two pairs, with Oscillators 1 and 3 as sync leaders. Each pair can be turned on and off separately.

1->2 On

[Off, On]

This appears only when **Mode** is set to *Double*.

On: Oscillator 1 is the sync leader, and Oscillator 2 is the follower.

Off: Oscillators 1 and 2 sound normally, without sync.

3->4 On

[Off, On]

This appears only when **Mode** is set to *Double*.

On: Oscillator 3 is the sync leader, and Oscillator 4 is the follower.

Off: Oscillators 3 and 4 sound normally, without sync.

Tip: Sync sweep

To create the classic sync sweep sound:

1. Turn on Oscillators 1 and 2, and turn off Oscillators 3 and 4.
2. Set Oscillators 1 and 2 to the *Classic Type*, and set their Waveforms to *Saw*.
3. Turn on Sync, and set the Mode to *Single*.
4. Select the Pitch Envelope.
5. Set Attack to around 1 second, and Decay to around 3 seconds.
6. Select Oscillator 2.
7. Hold SHIFT, and turn the envelope VELOCITY knob (PITCH ENV > OSC).

This adjusts the Pitch Envelope amount for the selected Oscillator.

8. Set the amount to +36.00.

If you like, you can turn Oscillator 1's **Level** down; the “sync” sound comes from Oscillator 2.

Tip: 3-oscillator sweep

This distinct sound is possible only with a four-oscillator structure, such as on the multi/poly and the original Mono/Poly.

1. Turn on all four Oscillators.
2. Set all Oscillators to the *Classic Type*, and set their Waveforms to *Saw*.
3. Turn on Sync, and set the Mode to *Single*.
4. Select the Pitch Envelope.
5. Set Attack to around 1 second, and Decay to around 3 seconds.
6. Select Oscillator 2.
7. Hold SHIFT, and turn the VELOCITY knob (PITCH ENV > OSC).
8. Set the amount to +12.00.
9. Repeat steps 6 through 8 for Oscillators 3 and 4, setting the amounts to +24.00 and +36.00, respectively.

X-Mod (Cross Modulation)

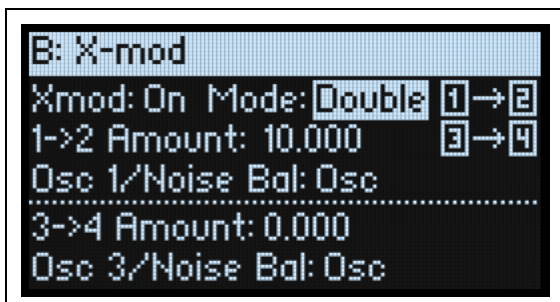

When X-Mod is On, the X-Mod leader (e.g. Oscillator 1) modulates the frequency of the X-Mod follower(s) (e.g. Oscillator 2). This results in a series of complex non-harmonic “sum and difference” frequencies above and below the root pitch, called side-bands. These side-bands can create metallic sounds, like bells or gongs.

Detuning the oscillators will further alter the sound. Additionally, sweeping the pitch of follower oscillators with an envelope, LFO, or other mod source will create a highly unusual “contrary motion” effect, with different pitches gliding in different directions.

The multi/poly provides various options for X-Mod between the four oscillators, as described below.

Xmod (X-MOD)

[Off, On]

On: X-Mod is enabled, according to the parameters described below.

Off: X-Mod is disabled.

Mode

[Single, Double]

Single: Oscillator 1 is the X-Mod source, and Oscillators 2, 3, and 4 are the receivers.

Double: The oscillators are grouped into two pairs, with Oscillators 1 and 3 as X-Mod sources. The X-Mod amount can be adjusted individually for each pair.

Amount (or 1->2 Amount)

[0.000...24.000]

This sets the amount of cross-modulation, in semitones. When **Mode** is set to *Double*, this parameter changes to **1->2 Amount**, and controls the amount for Oscillator 2 only.

Osc 1/Noise Bal (Osc 1/Noise Balance)

[Osc, 0.1...99.9, Noise]

This controls the relative levels of the source oscillator and the noise generator. When **Mode** is set to *Double*, this controls the Osc/Noise blend for Oscillator 2 only.

3->4 Amount

[0.000...24.000]

This appears only when **Mode** is set to *Double*, and controls the amount of cross-modulation from Oscillator 3 to Oscillator 4, in semitones.

Osc 3/Noise Bal (Osc 3/Noise Balance)

[Osc, 0.1...99.9, Noise]

This appears only when **Mode** is set to *Double*, and controls the relative levels of the source oscillator and the noise generator.

Tip: SYNC and X-MOD together

Combining both Sync and X-Mod together produces yet another group of sounds. As with X-Mod, one oscillator modulates others so as to produce side-bands. However, since the oscillators are also synchronized, the side-bands are harmonically related. The result of this is an intensified sweep of harmonics that can be characterized as “shimmering” and extremely powerful.

Oscillators

The X-Mod **Amount** has a pronounced effect upon the tonal quality of the combined effect. At its minimum value, the normal sync sweep is produced; increasing the **Amount** introduces gradual changes in the sound quality, creating greater timbral complexity.

Mixer 1

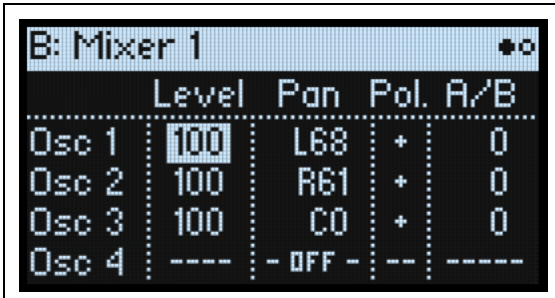

	Level	Pan	Pol.	A/B
Osc 1	100	L68	+	0
Osc 2	100	R61	+	0
Osc 3	100	C0	+	0
Osc 4	----	- OFF -	--	----

Osc 1/2/3/4

Oscillators 1 through 4, the Noise Generator, and the Ring Modulator each have identical controls in the mixer. Press the **OSC 1/2/3/4** buttons to select their respective parameters; press the same button twice to return to the main Waveform page.

Level (LEVEL)

[0...100]

This controls the element's volume.

Pan (SHIFT-LEVEL)

[L100...L1, C0, R1...R100]

This controls the element's stereo position. It is active only if Stereo Mix & Filters is On; see "Stereo" on page 38.

Pol. (Polarity)

[+, -]

This controls the element's signal polarity.

+: The element is heard with normal polarity.

-: The element is heard with inverted polarity.

A/B (Filter A/B Balance) (SHIFT-MORPH)

[0...100]

This controls the element's filter routing. At 0, it is routed through Filter A only; at 50, it is routed to both filters equally; and at 100, it is routed through Filter B only. For more information, see "Filter A/B Balance" on page 39.

Mixer 2

	Level	Pan	Pol.	A/B
Noise	19	C0		0
Ring	100	C0	+	0

Stereo Mix & Filters: On

Noise (Noise Generator) and Ring Mod (Ring Modulator)

The Noise Generator and the Ring Modulator have similar mixer controls to the Oscillators. For more information, see “Mixer 1” on page 37.

Level (LEVEL)

Pan (SHIFT-LEVEL)

Pol. (Polarity)

Note: **Polarity** is not available for the **Noise** input.

A/B (Filter A/B Balance) (SHIFT-MORPH)

Stereo

Stereo Mix & Filters

[Off, On]

This controls whether the Program is stereo or mono.

Off: Pan is disabled in the Mixer, and the Filter, Drive, and Amp sections run in mono. This option may allow for greater polyphony.

On: Pan is enabled in the Mixer, and the Filter, Drive, and Amp sections all run in stereo. This may reduce polyphony.

Filters

Serial and Parallel routing

Parallel (PARALLEL)

[Off, On]

There are two filters, Filter A and Filter B. They can be arranged either in parallel, or in series. In either case, **Filter A/B Balance**, described below, controls signal routing to the filters.

Press **SHIFT-TYPE** to turn Parallel on and off. The state is shown by the LED next to the button.

Off (Serial): the output of Filter A is processed through Filter B.

On (Parallel): sources are routed independently to Filter A and/or Filter B.

Serial, Parallel, and A/B Balance

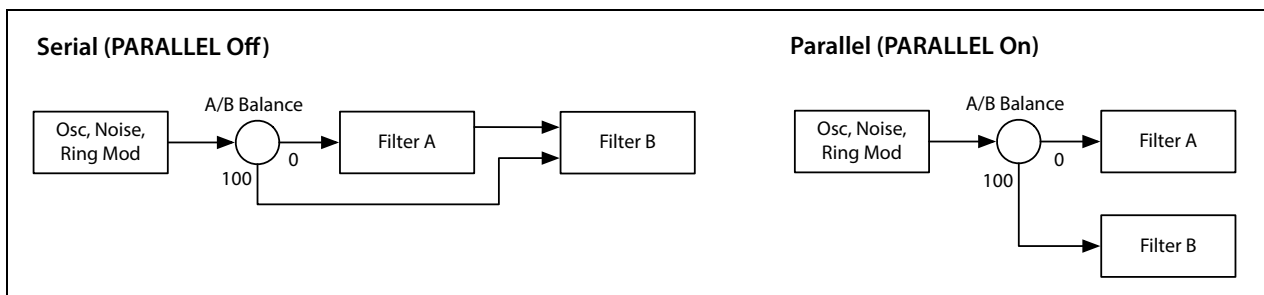

Filter A/B Balance

B: Mixer 1					B: Mixer 2				
	Level	Pan	Pol.	A/B		Level	Pan	Pol.	A/B
Osc 1	100	L68	+	0	Noise	19	C0		0
Osc 2	100	R61	+	0	Ring	100	C0	+	0
Osc 3	100	C0	+	0	Stereo Mix & Filters: On				
Osc 4	----	- OFF -	--	----					

The Mixer page's **A/B (Filter A/B Balance)** parameters let you separately control the filter routing for each of the six inputs: Oscillator 1/2/3/4, the Noise Generator, and the Ring Modulator. You can set these directly from the front panel using the **FILTER A/B** knob (**SHIFT-MORPH**).

When an input's **Filter A/B Balance** is set to 0, it goes into Filter A. (Note that if **PARALLEL** is *Off*, the signal will also pass through Filter B.)

If the input's **Filter A/B Balance** is set to 100, it goes directly into Filter B, regardless of whether **PARALLEL** is *On* or *Off*.

Standard serial configuration

To create a standard serial filter configuration:

1. Turn **PARALLEL** *Off*.
2. For all inputs, set **FILTER A/B** to 0.

This makes all of the inputs go to Filter A first, and then through Filter B.

Standard parallel configuration

To create a standard parallel filter configuration:

1. Turn **PARALLEL** *On*.
2. For all inputs, set **FILTER A/B** to 50.

This routes all of the inputs to both filters, at equal volumes.

Dual signal paths

You can also send some inputs through Filter A and others through Filter B, to create a layered sound. For instance:

1. Turn **PARALLEL On**.
2. Set Oscillator 1's **FILTER A/B to 0**.
3. Set Oscillator 2's **FILTER A/B to 100**.

This routes Oscillator 1 to Filter A.

This routes Oscillator 2 to Filter B.

Anywhere in-between

If an input's **FILTER A/B** is set between 1 and 99, it will go to a combination of both filters—so that many “in between” filter effects are available.

Finally, by modulating an input's **FILTER A/B**, you can crossfade between routing through Filter A and Filter B.

Filter overview

The basic filter types: LP, HP, BP, BR

LP (Low Pass). This cuts out the parts of the sound which are **higher** than the cutoff frequency. Low Pass is the most common type of filter, and is used to make bright timbres sound darker.

HP (High Pass). This cuts out the parts of the sound which are **lower** than the cutoff frequency. You can use this to make timbres sound thinner or more buzzy.

BP (Band Pass). This cuts out all parts of the sound, both highs and lows, except for the region around the cutoff frequency. Since this filter cuts out both high and low frequencies, its effect can change dramatically depending on the cutoff setting and the oscillator's waveform, Wavetable, or waveshaper settings.

With low resonance settings, you can use Band Pass filters to create telephone or vintage phonograph sounds. With higher resonance settings, it can create buzzy or nasal timbres.

BR (Band Reject). This filter type—also called a notch filter—cuts only the parts of the sound directly around the cutoff frequency. Try modulating the cutoff with an LFO to create phaser-like effects.

Important: a note about gain

Many filter types include saturation, which interacts with resonance. This includes *M/Poly*, *Mini*, *Pro*, *MS-20 LP* and *HP*, *SE M/P*, and *Ladder HP* and *BP*. With anything other than very low resonance settings, input volume can have a strong effect on their character. The **lower** the input gain, the more headroom remains for the resonance to bloom. The **higher** the input gain, the easier it is to reach saturation, leaving less headroom for resonance. Use **Trim** to control the input level.

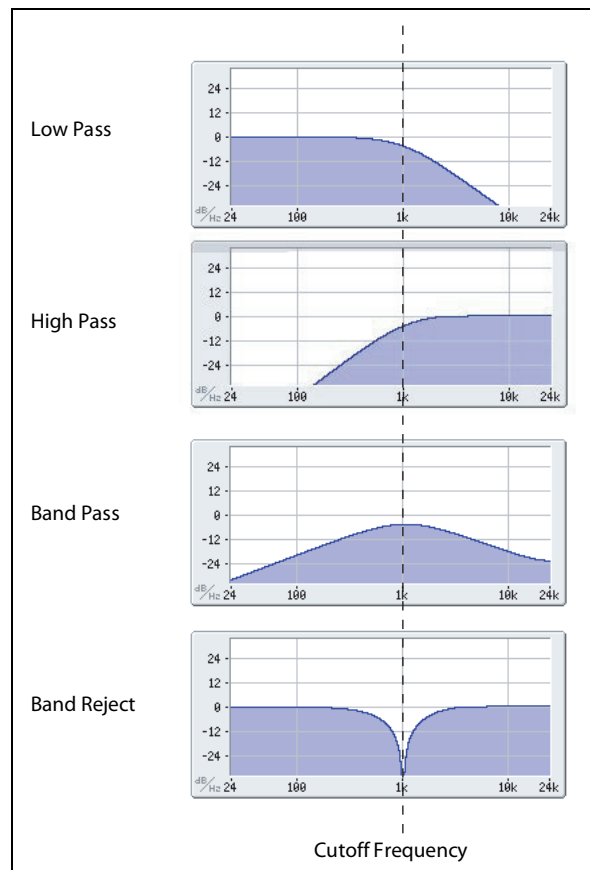

Filter A/B

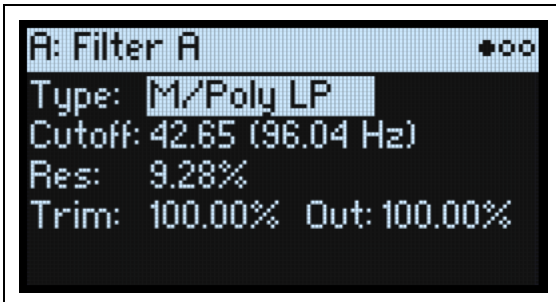

Filter A/B Off/On (SHIFT-FILTER A/B)

[Off, On]

Filters A and B can be enabled and disabled independently. Disabling one or both filters can increase the available polyphony.

SHIFT-press or double-press the **FILTER A** and **FILTER B** buttons to turn the filters on and off. The states are shown by the **ON** LEDs next to the buttons.

Off: the filter is disabled and bypassed. Signal routed through the filter will go directly to the Amp section.

On: the filter is enabled.

Type (FILTER TYPE)

[*M/Poly, Mini, Pro, MS-20 LP, MS-20 HP, SE M/P, Ladder HP, Ladder BP, 2-pole LP, 4-pole LP, 2-pole HP, 4-pole HP, 2-pole BP, 4-pole BP, 2-pole BR, 4-pole BR, Multi Filter*]

Pressing the front panel **FILTER TYPE** button selects and edits the **Type** parameter. Five useful settings are available directly: *M/Poly LP*, *MS-20 LP* and *HP*, *Mini*, and *SE M/P*. Many more types are available by editing the on-screen parameter. If in doing so you select one of the five types listed on the front panel, the front-panel **FILTER TYPE** LEDs will update to show the selection. Selecting any other Filter **Type** lights the **MORE** LED. If you switch between **Types** from the front-panel button, the **MORE** position remembers the last-used **MORE Type**.

M/Poly (Mono/Poly): This 4-pole (24dB/octave), self-resonating low-pass filter provides the strong, sweet sound of the classic Korg Mono/Poly. It's also very similar to the filter in the Korg Polysix.

Mini: The classic 4-pole ladder filter, from a beloved American mono-synth. **Resonance** is reduced at very low frequencies, producing the original synth's classic character on bass sounds.

Pro: The self-resonating 4-pole filter from the first programmable polyphonic synthesizer.

MS-20 LP and HP: These 12dB/octave, self-resonating "Korg 35" filters lovingly recreate the distinctive timbral signature of the classic Korg MS-20. Raising **Resonance** will cause increasing amounts of saturation and overdrive, creating a more aggressive tone. Input volume can have a strong effect on this character.

SE M/P: A 2-pole filter with a continuous control to sweep between lowpass, band reject, and highpass, plus a separate bandpass mode. **Resonance** is mild through most of the range, only becoming prominent in the last 15% or so. A classic synthesizer expander module used this type of filter.

Ladder HP, Ladder BP: These are 4-pole, self-resonating highpass and bandpass filters, respectively.

2-pole LP, HP, BP, and BR: These produce 12dB/octave slopes for LP and HP, and 6dB/octave for BP and BR. Unlike the *SE M/P*, cutoff frequency tracking is very precise, making them preferable when using resonance to generate a specific pitch. Their character is also flexible, with options for either *Mini* or *Pro* style resonance behavior.

4-pole LP, HP, BP, and BR: These produce 24dB/octave slopes for LP and HP, and 12dB/octave for BP and BR. In comparison to 2-pole filters, these create a sharper roll-off beyond the cutoff frequency with more delicate resonance. There's also an option for more prominent resonance, if desired, along with options for either *Mini* or *Pro* style resonance behavior. Unlike the other 4-pole filters, cutoff frequency tracking is very precise, making them preferable when using resonance to generate a specific pitch.

Multi Filter. This is a complex filter which is capable of all of the 2-pole filter types, and many more besides. See "What's a Multi Filter?" on page 44.

Filters

Cutoff (CUTOFF)

[-4.00...+138.00] (semitones)

This controls the cutoff frequency of the filter, in semitones mapped to MIDI note numbers (60.00 = middle C). The frequency in Hz is also shown. The specific effect of the cutoff frequency will change depending on the selected **Type**, as described above.

Res (RESONANCE)

[0.00... 100.00%]

Resonance emphasizes the frequencies around the cutoff frequency, as shown in the diagram below.

When this is set to 0, there is no emphasis, and frequencies beyond the cutoff will simply diminish smoothly.

At medium settings, the resonance will alter the timbre of the filter, making it sound more nasal, or more extreme.

At very high settings, the resonance can be heard as a separate, whistling pitch.

Filter Resonance

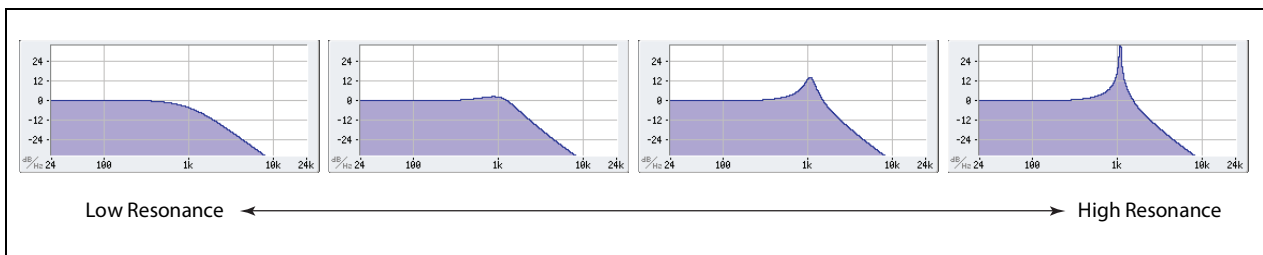

Trim

[0.00... 100.00%]

This adjusts the volume level at the input to the filter. With some filters, adjusting **Trim** can have a strong effect on timbre, especially in conjunction with high **Resonance** settings. For more information, see “Important: a note about gain” on page 40.

Out (Output Level)

[0.00... 100.00%]

This controls the output level of the filter. It’s useful for modulation (see “Notes on Amp Modulation” on page 53), and for balancing the volumes of Filters A and B when **Parallel** is *On*.

2-Pole LP/HP/BP/BR

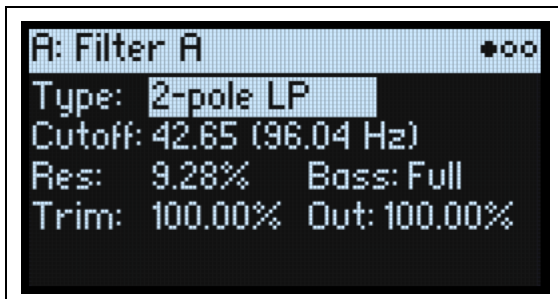

Bass (Resonance Bass)

[Full, Tight]

This is available only when **Type** is one of the 2-pole or 4-pole settings, or *Multi Filter*. **Resonance Bass** controls the character of the filter resonance at low cutoff frequencies. Its effect is most noticeable with high **Resonance** settings.

Tight produces a more restrained resonance, similar to a classic, American, wood-paneled monophonic synthesizer.

Full produces a wide, boomy resonance, reminiscent of a famous five-voice American synthesizer.

4-Pole LP/HP/BP/BR

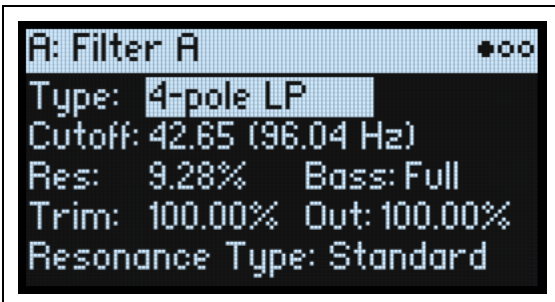

Resonance Type

[Standard, High]

Resonance Type is available only when using one of the *4-pole* filters.

Standard provides the resonance character of a typical analog 4-pole filter.

High creates a more pronounced resonance.

SE M/P

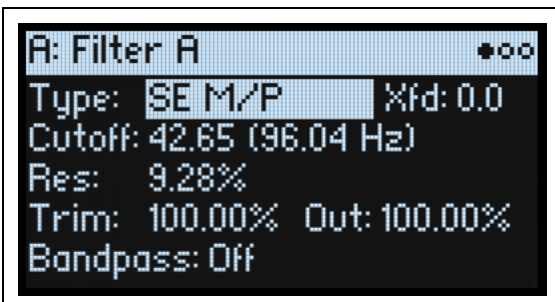

Xfd (MODE XFADE)

[0.0...100.0]

This is available only when **Type** is either *Multi Filter* or *SE M/P*. With the *SE M/P*, **Xfd** (crossfade) morphs between lowpass, band reject, and highpass. *0.0* is all lowpass, *50.0* is all band reject, and *100.0* is all highpass. Intermediate values mix between either lowpass and band reject (*0.1...49.9*) or band reject and highpass (*50.1...99.9*). Control this from the front panel using **MODE XFADE (SHIFT-RESONANCE)**. Note that this has no effect when **Bandpass**, below, is *On*.

Bandpass

[Off, On]

This is available only when **Type** is *SE M/P*.

Off: **Xfd**, above, controls the filter mode.

On: The filter switches to a bandpass-only mode. **Xfd** will have no effect.

Multi Filter

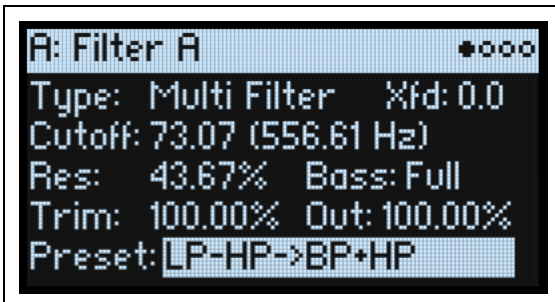

Xfd (MODE XFADE)

[0.0...100.0]

This is available only when **Type** is either *Multi Filter* or *SE M/P*. With the *Multi Filter*, **Xfd** (crossfade) morphs between the Mode 1 and Mode 2 settings. *0.0* is all Mode 1, *100.0* is all Mode 2, and *0.1...99.9* are intermediate values between the two Modes. Control this from the front panel using **MODE XFADE (SHIFT-RESONANCE)**.

Preset (Multi Filter Preset)

[List of Presets]

This is available only when **Type** is *Multi Filter*. Presets let you quickly select from a number of useful combinations of Modes 1 and 2. You can also select any combination you wish on the Multi Filter page, described below.

Multi Filter A/B

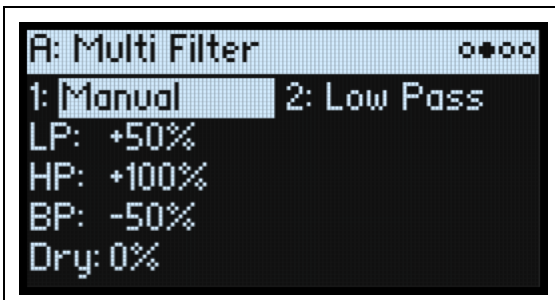

This page is available only when the Filter page **Type** is set to *Multi Filter*.

What's a Multi Filter?

Standard multimode filters generate low-pass, high-pass, and band-pass filters simultaneously—but only let you use one of them at a time. The Multi Filter gives you access to all three filter modes simultaneously, in any combination, along with the dry input signal. You can choose from a large number of preset combinations, or create your own complex filter modes using the Manual controls.

This is capable of some cool sounds in and of itself, but things really get interesting when you use **MODE XFADE** (see “Xfd (MODE XFADE)” on page 44). **MODE XFADE** allows you to mix between two of these filter settings (**Mode 1** and **Mode 2**), using modulation sources such as envelopes, LFOs, or real-time controllers.

1 (Mode 1)

[List of filter types]

This sets the filter type for Mode 1.

Low Pass, *High Pass*, *Band Pass*, and *Band Reject* are the standard filter types. For more information, see “Filter A/B,” on page 41.

LP+BP, *LP-BP*, *LP-HP*, *BP+HP*, *BP-HP*, *Dry+LP*, *Dry-LP*, *Dry+BP*, *Dry-BP*, *Dry+LP-HP*, *Dry+LP-BP*, *Dry+BP-LP*, *Dry+BP-HP*, *Dry+HP-LP*, *Dry+HP-BP*, *LP+HP+BP*: These combine two or more filters at equal volumes. *Dry* is the un-filtered input signal. The minus sign (“-”) indicates when the phase of a filter is reversed.

All On uses the Low Pass, High Pass, Band Pass, and Dry signals at equal volumes.

Filters

Manual lets you create your own mix of the filters; an additional four parameters will appear. For more information, see “Manual,” below.

2 (Mode 2)

Mode 2 has the same selections as Mode 1.

Manual

When Mode is set to *Manual*, these parameters let you create your own mix of the filters.

You may wonder why Band Reject is not included here. This is because it's not a filter mode per se. Instead, it's created by equal amounts of High Pass and Low Pass. Try it and see!

LP (Lowpass), HP (Highpass), BP (Bandpass), Dry

[-100%...+100%]

These set the volume of the Lowpass, Highpass, Bandpass, and Dry signals, respectively. Negative values invert the phase.

Filter A/B Mod

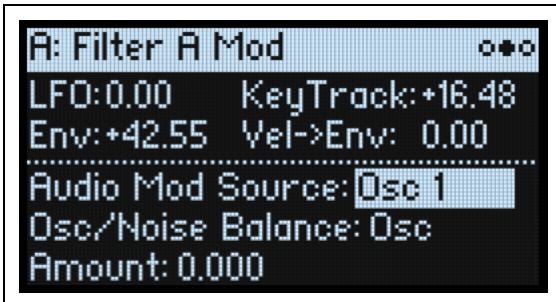

Default modulation routings

The four parameters at the top of the page control the default modulation routings for Filter Cutoff. Filters A and B each have their own dedicated envelope and LFO (via the **FILTER A** and **FILTER B** buttons in the envelope and LFO sections). You can create additional routings as desired; for more information, see “Adding Modulation Routings” on page 59.

LFO (INTENSITY)

[-142.00...+142.00]

This sets the amount of modulation from the filter’s LFO, in semitones.

Env (ENV INTENSITY)

[-142.00...+142.00]

This sets the amount of modulation from the filter’s Envelope, in semitones.

Vel->Env (VELOCITY)

[-142.00...+142.00]

This lets you use velocity to scale the amount of the filter’s Envelope applied to **Cutoff**, in semitones. To adjust this from the front panel, select the **FILTER** LFO and move the envelope’s **VELOCITY** knob.

Key Track (SHIFT-CUTOFF)

[-142.00...+142.00]

This controls how much the Key Track will affect the Cutoff frequency. The value is the amount, in semitones, that the filter will change over five octaves of keyboard with a standard -1.00/+1.00 slope. The overall effect of the Keyboard Track is a combination of this value and the Keyboard Track shape.

With positive values (+), the effect will be in the direction specified by keyboard tracking; if the Slope goes up, the Cutoff will *increase*.

With negative values (-), the effect will be in the opposite direction; if the Slope goes up, the Cutoff will *decrease*.

To create one-octave-per-octave key tracking (useful when creating pitch through filter resonance):

1. Set the Key Track amount to **+60.00** semitones.
2. In Filter Key Track, set Low and Low-Mid Slopes to **-1.00**, and Mid-High and High Slopes to **+1.00**.

Audio-rate modulation

In addition to standard modulation from LFOs, envelopes, and other sources, Cutoff can be modulated at audio rates by Oscillator 1/2/3/4, the Ring Modulator, and/or the Noise Generator. This can produce interesting bright, fizzy, and bubbling effects.

Audio Mod Source

[Osc 1...Osc 4, Ring Mod]

This selects the source to modulate the filter.

Filters

Osc/Noise Balance

[Osc, 0.1...99.9, Noise]

You can blend the Noise Generator into the Audio Mod Source, for more chaotic effects. This controls the relative levels of the selected Oscillator (or Ring Modulator) and the Noise Generator.

Amount

[0.000...36.000]

This controls the amount of modulation, in semitones.

Filter A/B Key Track



Most acoustic instruments get brighter as you play higher pitches. At its most basic, keyboard tracking re-creates this effect by increasing the cutoff frequency of a lowpass filter as you play higher on the keyboard. Usually, some amount of key tracking is necessary in order to make the timbre consistent across the entire range.

The multi/poly keyboard tracking can also be much more complex, since it allows you to create different rates of change over up to four different parts of the keyboard. For instance, you can:

- Make the filter cutoff increase very quickly over the middle of the keyboard, and then open more slowly—or not at all—in the higher octaves.
- Make the cutoff increase as you play *lower* on the keyboard.
- Create abrupt changes at certain keys, for split-like effects.

How Key Track works: Keys and Slopes

The keyboard tracking works by creating four ramps, or slopes, between five keys on the keyboard. The bottom and top keys are fixed at the bottom and top of the MIDI range, respectively. You can set the other three keys—named **Low**, **Mid**, and **High**—to be anywhere in between.

The four Slope values control the rate of change between each pair of keys. For instance, if the **Low-Mid Slope** is set to 0.00, the value will stay the same between the **Low Key** and the **Mid Key**.

You can think of the resulting shape as being like two folding doors attached to a hinge in the center. At the **Mid Key** (the main hinge), the keyboard tracking has no effect. The two folding doors swing out from this center point to create changes in the higher and lower ranges of the keyboard.

Slope

Positive slope values mean that the keyboard tracking output increases as you play farther from the Mid Key; negative slope values mean that it decreases. Because of this, the meaning of positive and negative slopes changes depending on whether the slope is to the left or right of the **Mid Key**.

Low and Low-Mid: negative slopes make the output go down as you play *lower* on the keyboard, and positive slopes make the output go up.

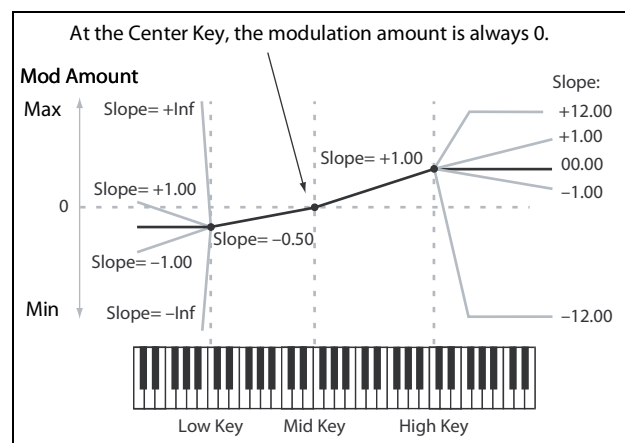

Filters

Mid-High and High: negative slopes make the output go down as you play *higher* on the keyboard, and positive slopes make the output go up.

The table below shows how the slopes affect the modulation output:

Slope value	Modulation change
-Inf	0 to minimum in 1 half-step
-10.00	0 to minimum in 6 semitones
-5.00	0 to minimum in 1 octave
-1.00	0 to minimum in 5 octaves
0	no change
+1.00	0 to maximum in 5 octaves
+5.00	0 to maximum in 1 octave
+10.00	0 to maximum in 6 semitones
+Inf	0 to maximum in 1 half-step

The final effect of Key Track is a combination of the Key Track shape and the modulation intensity. With greater Slope values, the Key Track shape can max out fairly quickly. Because of this, if you want a more intense effect, it's best to increase the modulation intensity first, rather than increasing the Slope.

+Inf and -Inf slopes

+Inf and -Inf are special settings which create abrupt changes for split-like effects. When a slope is set to +Inf or -Inf, the keyboard tracking will go to its extreme highest or lowest value over the span of a single key.

Note: if you set the **Mid-High Slope** to +Inf or -Inf, the **High Slope** will have no effect. Similarly, if you set the **Low-Mid Slope** to +Inf or -Inf, the **Low Slope** will have no effect.

Low Slope

[-Inf, -12.00...+12.00, +Inf]

This sets the slope between the bottom of the MIDI note range and the Low key. For normal key track, use negative values. -1.00 is the default.

(Low) Key

[C-1...G9]

This sets the breakpoint note between the two lower slopes—the “hinge” of the lower door.

 The Low Key can't be set above the Mid Key.

Low-Mid Slope

[-Inf, -12.00...+12.00, +Inf]

This sets the slope between the Low and Mid keys. For normal key track, use negative values. -1.00 is the default.

Mid Key

[C-1...G9]

This sets the center of the keyboard tracking—the main “hinge.” When this key is played, the Key Track output is 0.

 The Mid Key can't be set below the Low Key, or above the High Key.

Mid-High Slope

[-Inf, -12.00...+12.00, +Inf]

This sets the slope between the Mid and High keys. For normal key track, use positive values. +1.00 is the default.

High Key

[C-1...G9]

This sets the breakpoint note between the two higher slopes—the “hinge” of the upper door.

 The High Key can't be set below the Mid Key.

Filters

(High) Slope

[-Inf, -12.00...+12.00, +Inf]

This sets the slope between the High key and the top of the MIDI note range. For normal key track, use positive values. *+1.00* is the default.

Pitch

Osc Pitch

Osc Pitch

	Oct	Tune	Transpose
Osc 1	0	0.00	0
Osc 2	0	0.00	0
Osc 3	0	0.00	0
Osc 4	---	OFF	---

Osc 1/2/3/4

Each Oscillator has independent settings for Octave, Transpose, and Tune. Press the **OSC 1/2/3/4** buttons to select their respective parameters; press the same button twice to return to the main Waveform page.

Oct (OCTAVE)

[-2, -1, 0, +1, +2]

This sets the basic pitch of the Oscillator, in octaves. The default is 0.

Transpose

[-12...+12]

This adjusts the pitch of the Oscillator in semitones, over a range of ± 1 octave.

Tune (TUNE)

[-12.00...+12.00]

This adjusts the pitch of the Oscillator in semitones with high resolution (good for continuous modulation), over a range of ± 1 octave.

Common Pitch

A: Common Pitch	
Octave: 0	Transpose: 0
Tune: 0.00	Slope: +1.00

Portamento: Off	Fingered: Off
Type: Vintage Exponential	
Time: 0.062 sec	

These settings apply to all four Oscillators. Press **PITCH** to go to this page.

Octave

[-2, -1, 0, +1, +2]

This sets the basic pitch, in octaves. The default is 0.

Pitch

Transpose

[-12...+12]

This adjusts the pitch in semitones, over a range of ± 1 octave.

Tune

[-12.00...+12.00]

This adjusts the pitch in semitones, over a range of ± 1 octave.

Slope

[-1.00...+2.00]

This controls how pitch tracks the keyboard. Normally, it should be set to the default of $+1.00$.

Positive (+) values cause the pitch to rise as you play higher on the keyboard, and negative (-) values cause the pitch to *fall* as you play higher on the keyboard.

When **Slope** is 0.00 , playing different notes on the keyboard won't change the pitch at all; it will be as if you're always playing C4.

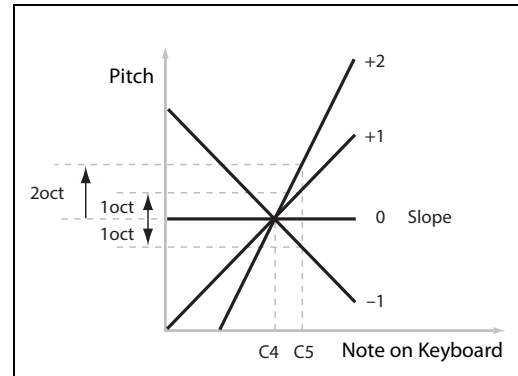

Portamento

Portamento

[Off, On]

Portamento lets the pitch glide smoothly between notes, instead of changing abruptly.

On: Turns on Portamento, so that pitch glides smoothly between notes.

Off: Turns off Portamento. This is the default.

Fingered

[Off, On]

Fingered applies only when **Portamento** is *On*.

On: Playing legato will turn on portamento, and playing detached will turn it off again.

Off: Legato/detached playing will not affect portamento.

Type

[Constant Rate, Constant Time, Vintage Linear, Vintage Mini, Vintage Exponential, Vintage MS-20]

Different portamento models can create very different effects; try them out!

Constant Rate: Portamento will always take the same amount of time to glide a given distance in pitch—for instance, one second per octave. Put another way, gliding several octaves will take much longer than gliding a half-step.

Constant Time: Portamento will always take the same amount of time to glide from one note to another, regardless of the difference in pitch. This is especially useful when playing chords, since it ensures that each note in the chord will end its glide at the same time.

Vintage Linear: This produces portamento with a linear ramp, which turns into a soft corner as it approaches the target pitch, like a classic American 5-voice synthesizer.

Vintage Mini: This uses a high-gain differential amplifier + lag filter, as in the vintage “mini” synth. It produces a nearly linear region and soft landing similar to *Vintage Linear*, but is faster when going up in pitch, and slower when going down.

Vintage Exponential: This uses a simple RC lag filter, as in the Korg Mono/Poly, ARP Odyssey, and vintage American “east-coast” modular systems.

Vintage MS-20: This uses a Hz/V frequency RC lag filter (as opposed to 1V/octave pitch), as in the Korg MS-20.

Time

[0.000...50.000 secs or s/oct]

This controls the portamento time. If **Type** is set to *Constant Rate*, *Vintage Linear*, or *Vintage Mini*, the units are s/oct (seconds per octave). If **Type** is set to *Constant Time*, *Vintage Exponential*, or *Vintage MS-20*, the units are simply secs (seconds). Note that these timings are approximate, and with *Vintage Mini* in particular, times will vary depending on whether the pitch is going up or down.

Pitch

Gated

[Off, On]

Gated is available only when **Voice Assign Mode** (see page 10) is set to *Mono*.

On: Portamento runs only while a note is held, and freezes in place when the note is released.

Off: Portamento continues to run after the note is released.

Common Pitch Mod



These settings apply to all four Oscillators. To modulate the pitches of individual Oscillators, use the Osc Pitch page instead.

LFO (INTENSITY)

[-144.00...+144.00]

This controls the initial effect of the Pitch LFO on the pitch, in semitones. To adjust this from the front panel, select the **PITCH** LFO and move the **INTENSITY** knob.

MW->LFO (Mod Wheel->LFO Intensity)

[-144.00...+144.00]

This controls the effect of the Mod Wheel on pitch modulation from the Pitch LFO, in semitones. +1 (one semitone) is a good starting point for vibrato.

Env (Envelope Intensity)

[-144.00...+144.00]

This controls the initial effect of the Pitch Envelope on the pitch, in semitones.

Vel->Env (Velocity->Envelope Intensity) (VELOCITY)

[-144.00...+144.00]

This controls the effect of velocity on pitch modulation from the Pitch Envelope, in semitones.

Detune

[0.0...35.0] (cents)

This control is from the original Mono/Poly, where it was intended to provide a quick control over timbral thickness, easier than adjusting tuning for the different Oscillators individually. It tunes Osc 2 down, and Osc 4 up, by the specified amount in cents (1/100 of a semitone). Osc 1 and Osc 3 are not affected.

Pitch Bend Up

[-60...+60] (semitones)

This sets the maximum amount of pitch bend, in semitones, when you move the wheel above the center point. For normal pitch bend, set this to a positive value.

Down (Pitch Bend Down)

[-60...+60] (semitones)

This sets the maximum amount of pitch bend, in semitones, when you move the wheel below the center point. For normal pitch bend, set this to a negative value.

Amp

Amp

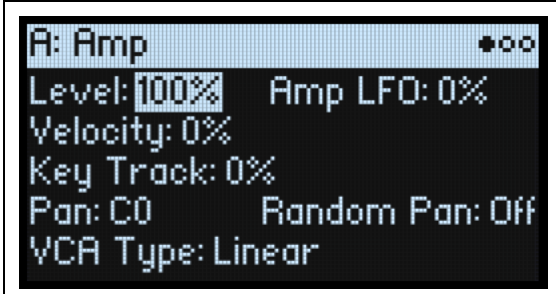

Press **AMP** to go to this page.

Notes on Amp Modulation

Amp modulation scales the Amp **Level** and Amp Envelope, with an upper limit of 2x the original settings to prevent uncontrollably loud output. If the original level is low, the maximum modulated volume will also be low.

(For the technically inclined: Amp modulation is multiplicative. Modulation values are offset by +1.0, so that a value of 0 has no effect. The maximum modulation value—for example, moving the Mod Wheel all the way up—doubles the volume level if the Intensity is +100%, or brings the level to silence if the Intensity is -100%.)

Tip: To start with a low level (or silence) and then use modulation to raise the level to maximum, use the Filter **Output Level** instead.

Level

[0%...100%]

This sets the basic volume of the Program, optimized for per-voice modulation. For adjusting the volumes of Programs within a Performance, it's better to use Layer **Volume** instead.

Amp LFO (INTENSITY)

[-100%...+100%]

This controls the amount of modulation from the Amp LFO.

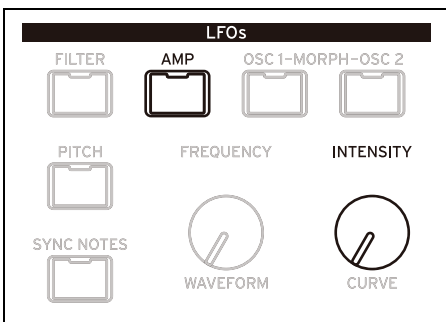

Velocity (VELOCITY)

[-100%...+100%]

This reduces volume according to velocity.

With *positive* (+) values, the volume increases as you play harder.

With *negative* (-) values, the volume decreases as you play harder.

Key Track

[-100%...+100%]

This adjusts the intensity of Key Track's effect on the level.

Amp

Pan

[L100...L1, C0, R1...R100]

This sets the left-right pan. Note that this can be modulated per voice!

Random Pan

[Off, On]

Off: The normal pan controls, above, apply.

On: Each voice will be randomly panned across the stereo field. All other pan controls are disabled.

VCA Type

[Linear, Mono/Poly, MS-20, Odyssey, Mini, Pro]

Analog VCAs don't respond evenly to voltage, which affects the perceived shape of modulation—and in particular the character of the Amp Envelope. Also, different VCAs turn on and off at different voltage thresholds; this can have a significant effect on the time and shape of the Amp Envelope's **Release Time**. This setting models the voltage response of the VCA for several different vintage instruments. For accurate modeling of a specific instrument, set the Amp Envelope's Curve **Preset** to match the **VCA Type** (see "Preset" on page 67).

Amp Key Track



Keyboard tracking (“Key Track”) changes the volume as you play up and down the keyboard. This may be used to make the volume more consistent, or to create special effects.

The multi/poly’s Key Track can be fairly complex, if desired. For instance, you can:

- Make the volume increase very quickly over the middle of the keyboard, and then increase more slowly—or not at all—in the higher octaves.
- Create abrupt changes at specific keys.

You can also use Amp Key Track as a general-purpose modulation source, just like the envelopes and LFOs.

For general details on how Key Track works, see “Filter A/B Key Track” on page 47.

Differences from Filter Keyboard Track

Amp modulation works slightly differently from other mod routings, in that positive modulation is limited to 2x gain. For more information, see “Notes on Amp Modulation” on page 53. This means that, when applied to Amp **Level**, Amp Key Track’s negative **Slopes** act as if they are steeper than positive **Slopes**. This only applies to modulation of Amp Level; when modulating other destinations, Amp Key Track acts the same as Filter Key Track.

Key Track amount	Slope	Change in level
100%	-Inf	Silent in one half-step
	-12.00	Silent in five semitones
	-5.00	Silent in one octave
	-1.00	Silent in five octaves
	0.00	no change
	+1.00	2x in five octaves
	+5.00	2x in one octave
	+12.00	2x in five semitones
+Inf	2x in one half-step	

Drive

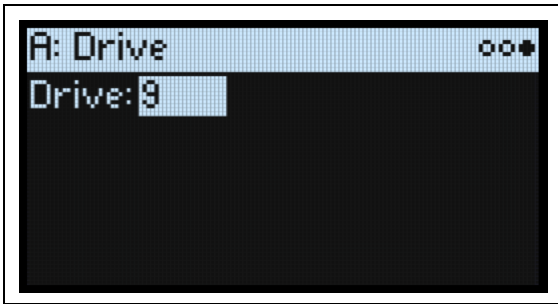

Press **SHIFT-AMP** to go to this page.

Drive adds anti-aliased overdrive to the signal chain, after the Filters and before the Amp. It's particularly effective when combined with filter resonance.

Drive

[0...100]

This sets the intensity of the overdrive.

Drift

Drift/Voice Variation

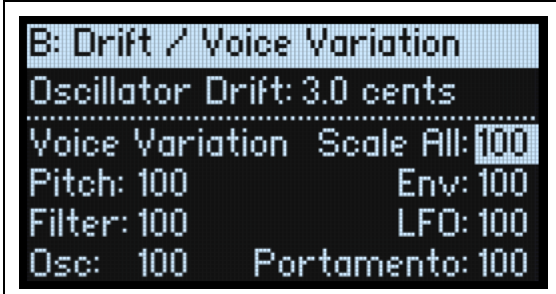

Virtual voice cards and drift

The multi/poly includes two separate but related mechanisms to model the subtle variations in sound between individual voices of an analog synthesizer. First, each voice uses a different Virtual Voice Card. Each voice card's oscillators, filters, envelopes, and LFOs behave slightly differently, modeling analog hardware component variations. The instrument's specific set of Virtual Voice Cards is determined by the CMT ID; see "CMT ID" on page 116.

Just like in an analog synth, voice cards remember their state, such as filter cutoff and resonance, envelope levels, oscillator phase, and so on. These persist as long as the Performance is selected. This works especially well with **Max # of Notes** (see "Max # of Notes" on page 10); if you set up a four-voice Program, for instance, each of those four voices always has the same character, regardless of what's happening in other Layers.

No two oscillators in a voice behave the same way; nor do two voices in a patch, nor the same Program in different Layers. Unless the global CMT ID is the same, two multi/poly instruments will also sound slightly different! But even with these differences, MIDI sequences are completely repeatable; the same voice in the same Program in the same Layer always behaves the same way.

In addition to all of the above, each oscillator's pitch can drift slightly over time, modeling the slight pitch instabilities found in analog hardware.

Oscillator Drift

[0.0...10.0 cents]

Oscillators will be detuned by up to this amount, creating a naturally "fat" sound. A value around 3.0 cents is a good place to start. The amount of detuning will slowly change over time, like the oscillators in a vintage analog synthesizer. In double saw waveforms, each has its own drift.

Voice Variation

This controls the amount of variance from the Virtual Voice Cards. For the normal amount of variation, set all controls to 100.

Scale All

[0...200]

This scales all of the individual controls below. 100 is the default. To model an instrument which is particularly out-of-calibration, you can increase this up to 200 (double the variation).

Pitch

[0...100]

This controls the amount of variation in *modulation* for pitch and x-mod. Note that oscillator pitch is controlled by **Oscillator Drift**, above.

Filter

[0...100]

This controls the amount of variation in Cutoff frequency and audio-rate filter modulation.

Drift**Osc****[0...100]**

This controls the amount of variation in PW/Morph and PW/Morph modulation.

Env**[0...100]**

This controls the amount of variation in envelope segment times.

LFO**[0...100]**

This controls the amount of variation in LFO frequency, delay, and fade times.

Portamento**[0...100]**

This controls the amount of variation in portamento times. The original Mono/Poly was deliberately configured with different times for the different notes, creating a distinctive, complex portamento effect.

Modulation

Using Modulation

Modulation Overview

Most front-panel controls and on-screen parameters can be modulated. You can also create multiple modulation routings to the same destination. Each modulation routing includes a primary modulation source, an intensity, and a secondary modulation source; the three are multiplied together to create the modulation amount. Once a modulation routing is created, you can change either of the sources, but you cannot change the destination.

Adding Modulation Routings

To add a new Modulation routing:

1. In the display, select the parameter that you'd like to modulate. (If you want to modulate a knob, you can skip this step.)
2. Hold **MOD** and press **>**.

The Add New Modulation popup appears.

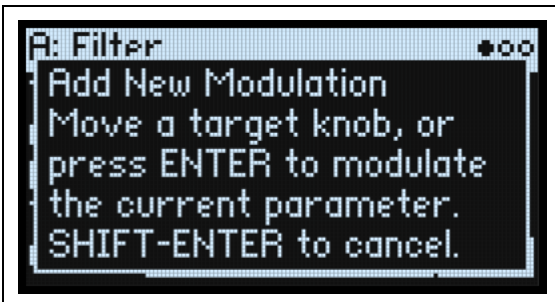

3. To select the modulation destination, move its front-panel control (e.g., **CUTOFF**), or press **ENTER** to select the parameter from step 1.

Note: If the selected parameter cannot be modulated, a message will appear on the display and then the popup will close.

4. To select the modulation source, move a controller (e.g. the Mod Wheel) or a **MOD KNOB**, play a note (for Velocity), press a button for one of the LFOs, Envelopes, or Step Seq Lanes, or send a MIDI CC.

Alternatively, if you want to use a mod source which can't be selected from the front panel (such as Exponential Velocity or Mod Processors), press **ENTER** and manually select the mod source in the following screen.

If the message "Chan Src Only" appears, the parameter cannot be modulated from per-voice sources such as LFOs, envelopes, Step Seq Lanes, and Key Track. Choose a different modulation source.

5. Press **ENTER** to create the mod routing, or **SHIFT-ENTER** to cancel.

The Mods page appears, showing the new routing.

6. Set the Intensity as desired.

The maximum Intensity is typically +/- the full range of the parameter, so that regardless of the programmed value, modulation can always reach the minimum or maximum values.

7. Optionally, assign a second modulator as the Int Mod (Intensity Mod Source), whose value multiplies that of the main Source.

For example, you could route Step Seq Lane B to Multi Filter **Crossfade**, with the overall amount of the step sequencer modulated by the Osc 1 LFO.

Filter/Pitch Env Intensities, LFO Intensities, and Key Track Intensities

Modulation works slightly differently for these "Intensity" parameters. When you select them as a destination:

- The modulation destination is set to the main parameter: Filter A Cutoff, Amp Level, Osc 1 Position, etc.
- The Source is set to the Envelope, LFO, or Key Track
- The Intensity Mod Source is set to the selected modulation source (as selected in step 4, above).

Modulation

Filter A/B and Pitch Env Velocity Intensity

Filter A/B and Pitch Envelope Velocity Intensity parameters cannot themselves be modulated.

Viewing and Editing Modulations

All user-created modulation routings can be viewed and edited on the Mods page.

Note: Built-in modulation routings, such as Filter Envelope modulation of Filter Cutoff or Osc 1 LFO modulation of Osc 1 Morph, are not shown here.

To view modulation routings:

1. Press **MOD**. The screen will change to the Mods page, which displays all of the modulation routings in the current Program in a scrolling list.

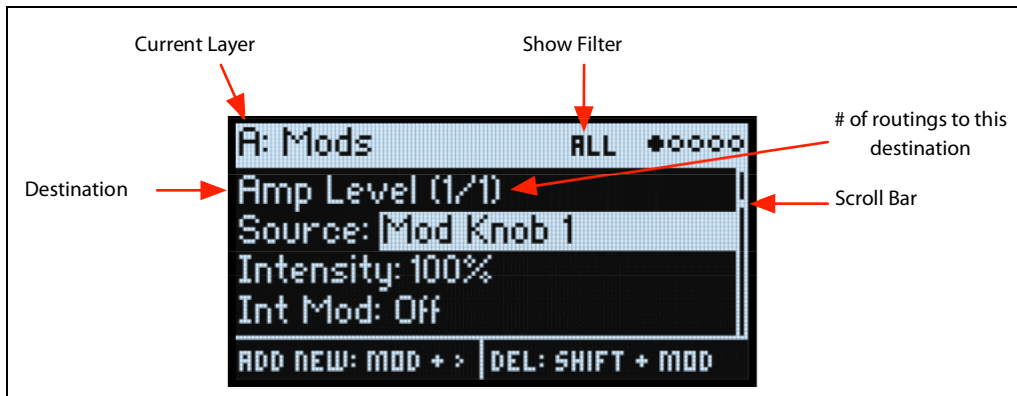

2. Hold **ENTER** and press **<** or **>** to scroll through the different routings.

Alternatively, you can cursor through each parameter, one by one; cursoring right from Int Mod Src goes to the Source parameter of the next routing.

A scroll-bar on the right side of the display shows the current location in the list.

When you see the modulation routing that you'd like to edit:

3. Use **<** and **>** to select the Source, Intensity, and Int Mod (Intensity Mod Source) parameters.
4. Edit the Intensity as desired using the **VALUE** knob.
5. To change the Source or Int Mod, select the parameter and then either turn **VALUE** or press **ENTER**. The Modulation Source popup appears.

In the Modulation Source popup, the modulation sources are organized into five groups: Controllers, Mod Knobs, Generators, CC +, and CC +/- . The groups are shown in the left column, and the modulation sources are shown in the right column.

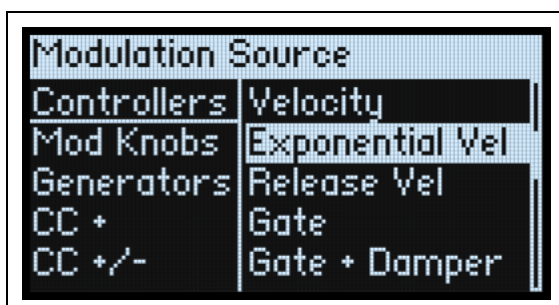

6. Use **<** and **>** to move between the columns, and **VALUE** to select items in the lists. Alternatively—and faster!—most modulation sources can be selected by pressing their associated front-panel button (for Envelopes, LFOs, and the Seq Lanes), or by holding down **ENTER** and moving a controller (such as a Mod Knob, wheel, or the Kaoss pad), playing a note on the keyboard (for Velocity), or sending MIDI data.

For information on the individual modulation sources, see “Modulation Sources” on page 62.

7. Press **ENTER** to confirm and exit the popup.

Filtering the modulation list

The list of modulations can be long. To view only the modulation routings related to a specific controller or section of the synth, use the Show parameter on the Modulation List Info page. As a shortcut to open this parameter's popup from anywhere in the UI, hold **MOD** and press **<**, as described below:

1. Hold **MOD** and press **<**.

The Show In Mod List dialog appears.

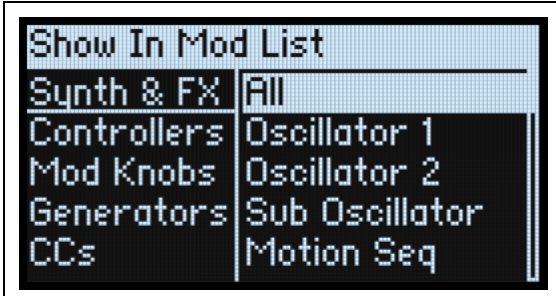

2. Press **AMP**, **PITCH**, **FILTER TYPE**, **OSC 1-4**, **NOISE**, **RING MOD**, **SYNC**, **X-MOD**, **KAOSS**, or an **Envelope**, **LFO**, or **Effect** button; press a **Lane** button (pressing **SHIFT** is not required for Lane selection here); move a **MOD KNOB**; hold **ENTER** and move a controller or play a note on the keyboard (for Velocity); or send a MIDI message. Use the on-screen list for other selections, such as **Key Track** or **Mod Processors**.

Note: moving a knob in this popup will not edit the knob's parameter.

3. Press **ENTER** to confirm, close the popup, and return to the **Mods** page. Alternatively, to exit without making a change, hold **SHIFT** and press **ENTER**.

The Show setting is included in the top line of the display: **ALL**, **FILTER**, **SHAPE LANE**, etc. The list will be filtered to show only the matching items—notice how much bigger the scroll-bar thumb is in the filtered list below, indicating that there are only a few items in the list.



To clear the Show setting and show all modulations:

1. Press **MOD** in the **Show In Mod List** dialog, or set **Show** to **All**.

Deleting a modulation routing

To delete the currently shown modulation routing:

1. Hold **SHIFT** and press **MOD**.

A confirmation message will appear, asking if you want to delete the modulation routing.

2. Press **ENTER** to confirm, or any other key to cancel.

Mod Knobs

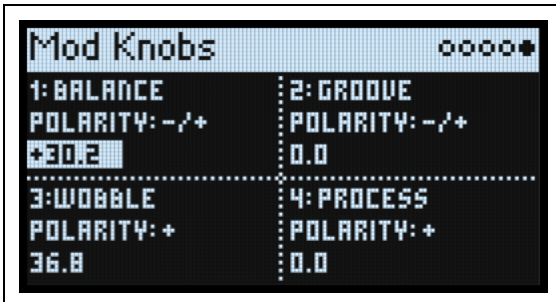

You can use the Mod Knobs in real-time performance, and also save the results as new sounds. The names and values are shown on the main PERFORM screen. The values are stored, and can themselves be modulated by the wheels, Kaoss Physics, and MIDI CCs. The Mod Knobs can control either or both Layers at once. Each knob sends and receives a MIDI CC; see “MIDI CC Assign” on page 120.

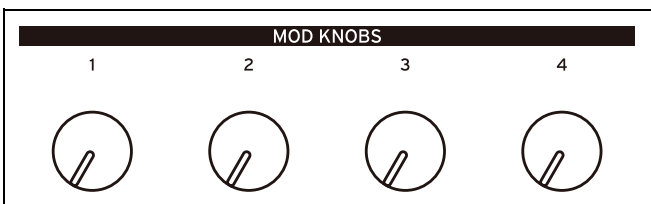

(Name)

The Mod Knobs can be named; there’s room for about 12 characters on the main Perform page.

To edit the name:

1. Select the name parameter.
2. Press **ENTER**.

The Name page appears. For more information, see “Editing names” on page 15.

Polarity

[+, -/+]

Each Mod Knob can be either unipolar (+) or bipolar (+/-).

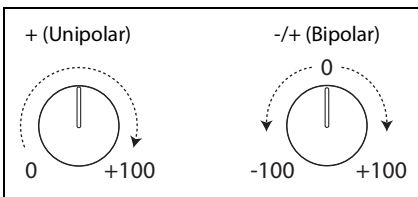

(Value)

[-100.0...+100.0]

This is the current value of the Mod Knob. When Polarity is +, values are positive only.

Modulation Sources

Controllers

Off

This means that no modulation source is selected.

Mod Wheel CC 1

This is the built-in Mod Wheel (unipolar MIDI CC#1).

Modulation

Kaoss Btn CC 12

This is the front-panel **KAOSS** button (unipolar MIDI CC#12).

Damper CC 64

This is the damper or sustain pedal (unipolar MIDI CC#64).

Pitch Bend

This is the Pitch Bend wheel (MIDI Pitch Bend).

Pitch Bend+ and Pitch Bend-

These let through only positive or negative pitch bend movements, respectively, ignoring the other polarity.

Velocity

This is the note-on velocity, representing how hard the note is played on the keyboard.

Exponential Vel (Exponential Velocity)

This is MIDI note-on velocity through an exponential curve. Low velocities won't have very much effect, and the differences between lower velocities won't be very noticeable. On the other hand, high velocities produce increasingly greater effects, and the differences between higher velocities will be more pronounced.

Release Velocity

This is the note-off velocity, representing how quickly the note is released from the keyboard.

Gate and Gate+Damper

Gate is triggered by a new note after all notes have been released, such as at the beginning of a phrase. Gate+Damper is similar, except that it is triggered by a new note-on after all notes and the damper are released.

Note-On Trig and NoteTrig+Damp

Note-On Trig is similar to Gate, but it triggers with every new note-on, even in the middle of a legato phrase.

NoteTrig+Damp includes the damper pedal in the equation, as shown in the diagram below.

Gate, Gate+Damper, Note-On Trig, and NoteTrig+Damp

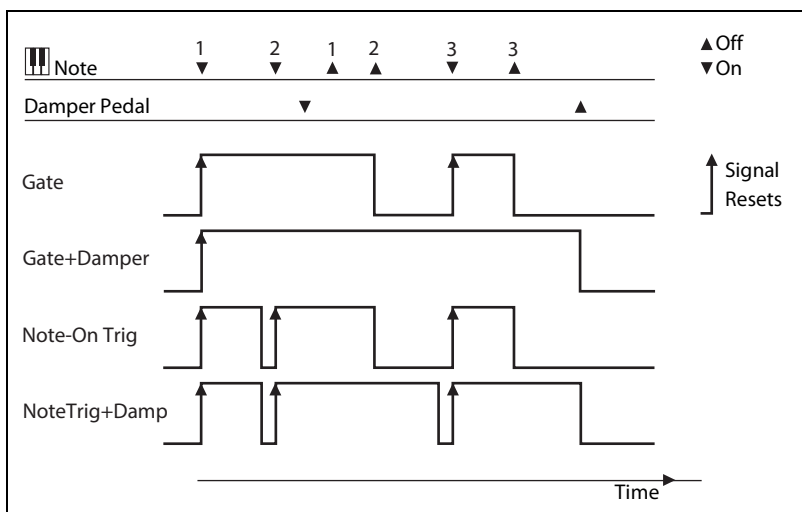

Note Number

This provides simple key tracking. C4 is the center, with a value of 0. Below C4 is negative, to a minimum at MIDI note 0; above C4 is positive, to a maximum at MIDI note 127.

Aftertouch and Poly Aftertouch

These are MIDI Channel Aftertouch and Poly Aftertouch, respectively, representing pressure on the keyboard after note-on. Aftertouch can be globally switched to respond to Channel Aftertouch, Poly Aftertouch, both, or neither; for details, see "AT Source (Aftertouch Source)" on page 119.

Note: the multi/poly keyboard does not generate aftertouch.

Modulation

Kaoss X

Kaoss X is the horizontal position of the Kaoss ball: negative to the left of center, 0 in the middle, and positive to the right.

Kaoss Y

Kaoss Y is the vertical position of the Kaoss Ball: negative below the center, 0 in the middle, and positive above the center.

Kaoss Distance

Kaoss Distance is the distance from the center, which is always positive.

Kaoss Angle

Kaoss Angle is the current angle of the ball relative to the x axis. The value is always positive, regardless of whether it is above or below the x axis.

Kaoss X+/X-/Y+/Y-

Kaoss X+, *X-*, *Y+*, and *Y-* are unipolar versions of *Kaoss X* and *Kaoss Y*. They produce a positive signal on one side of the center point; on the other side, the output is always 0. This lets you create four independent modulation routings emanating from the center of the pad: right, left, up, and down.

Mod Knobs

This section of the list contains the 4 Mod Knobs.

Generators

Filter A, Filter B, Amp, and Pitch Envelope

These are the four ADSR envelopes.

Filter A, Filter B, Amp, Pitch, and PW/Morph LFO

These are the five LFOs.

Filter A, Filter B, and Amp Key Track

These are the Key Track generators from the Filter and Amp, respectively.

Perf ModProc 1/2 (Performance Mod Processor 1/2)

These are the two Performance-level Mod Processors.

Prog ModProc 1/2 (Program Mod Processor 1/2)

These are the two Program-level Mod Processors.

Mod Proc 1/2/3/4 (Mod Processor 1/2/3/4)

These are the four voice-level Mod Processors.

Step Pulse

This generates a brief trigger pulse at the start of each Sequence Step.

Step Seq A-D

These are the outputs of the four Sequence Lanes.

Step Pitch

This allows you to use the Pitch Lane as a modulation source. For modulation destinations which use semitone units, an Intensity of +1.0 produces one semitone of modulation for each one semitone change in the Pitch Lane. This is convenient for modulating Filter Cutoff, for instance, Note that this means that the overall signal level can be very high.

Motion Seq On

This is at maximum when the Motion Sequence is enabled, and at 0 when it is disabled. Note that via modulation, the Motion Sequence can be enabled/disabled on a per-voice basis.

Modulation

Tempo

This lets you use the system tempo as a modulation source. 120 is the center, for a value of 0; 60BPM is -100, and 240BPM is +100 (the value continues to increase up to 300BPM). Note that this is different from tempo synchronization; for that purpose, use the dedicated Tempo functions for the LFOs and Motion Sequence.

Perf #of Notes, Perf #of Voices, Prog #of Notes, Prog #of Voices

These use the number of notes played on the keyboard, or the number of voices being played by the synth engine, as modulation sources. *Perf #of Notes* and *Perf #of Voices* count all notes or voices in the Performance, while *Prog #of Notes* and *Prog #of Voices* only include those in the current Program.

# Notes/Voices	Resulting value
1	0.0
2	0.01
3	0.02
...	...
101	1.0

Poly Legato

When you play a legato phrase, the first note of that phrase (and notes within 30 msec of the first note) has a Poly Legato value of 0.0. Subsequent notes in the phrase have a Poly Legato value of 1.0.

Random 1 + and 2 +

These generate a single random positive number, unique per voice, at note-on. You can use this to create random variation between voices, such as subtle differences in filter cutoff, envelope times, and so on.

Random 3 +/- and 4 +/-

These generate a single random bipolar number (either positive or negative), unique per voice, at note-on.

Constant Max

Constant Max generates the maximum modulation value, which can be thought of as either 1.0 or 100.

CC +

This is a list of all of the MIDI CCs, interpreted as unipolar signals. MIDI values 0-127 are zero to maximum modulation.

CC +/-

This is a list of all of the MIDI CCs, interpreted as bipolar signals. MIDI value 64 is 0; values below 64 produce negative modulation, and values above 64 produce positive modulation.

Envelopes

Filter A/Filter B/Pitch/Amp Envelope

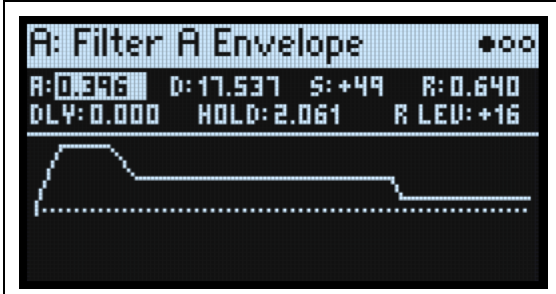

DLY (Delay Time)

[0.000...90.000] (seconds)

This sets the time between the envelope being triggered and the start of the **Attack Time**.

A (Attack Time) (ATTACK)

[0.001...90.000] (seconds)

This sets how long the envelope takes to rise to the peak level. Note that when voice cards are re-used, the envelope may start from a level other than zero, just like on a vintage analog synth; see “Virtual voice cards and drift” on page 57.

Hold (Hold Time)

[0.000...90.000] (seconds)

This sets the time between the end of the **Attack Time** and the start of the **Decay Time**.

D (Decay Time) (DECAY)

[0.001...90.000] (seconds)

This sets how long it takes to settle from the peak to the **Sustain** level.

S (Sustain Level) (SUSTAIN)

[-100...+100 (Filter A/B and Pitch) or 0...+100 (Amp)]

This sets the level at the end of the **Decay** time. Once it reaches the **Sustain** level, the envelope will stay there until note-off, unless it is restarted via the **Trigger Source**. The Filter and Osc 1/2 Envelopes can have either positive or negative **Sustain** levels, while the Amp Envelope has only positive **Sustain** levels.

R (Release Time)

[0.001...90.000] (seconds)

This sets how long it takes the envelope to return to 0 after releasing a note.

R Lev (Release Level)

[-100...+100]

This sets the level at the end of the **Release** time.

Important: this is not available for the Amp Envelope, which must always release to a level of 0.

Filter A/Filter B/Pitch/Amp Envelope Curve

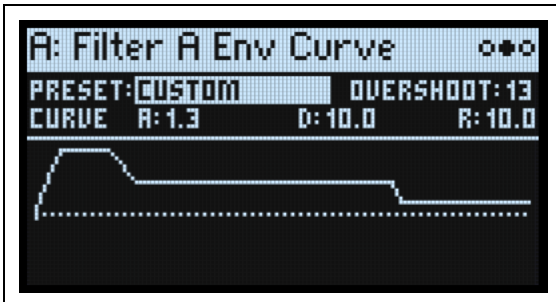

Often, envelopes are pictured as being made out of straight lines. In actuality, they are more likely to be made out of curves.

In other words, each segment's level will change quickly at first, and then slow down as it approaches the next point. When controlling natural aspects of sound such as volume, brightness, and pitch, this tends to sound better than straight, linear segments. (See note below regarding Wavetable modulation.)

Classic analog synth envelopes made these curved shapes naturally. The multi/poly goes a step further than vintage synths, however, and lets you control the amount of curvature separately for each envelope segment.

When you change the curvature, the envelope times remain the same. However, greater curvatures will tend to *sound* faster, because the value changes more quickly at the beginning.

Preset

[Custom, Mono/Poly, MS-20 EG 1, MS-20 EG 2, Odyssey ADSR, Odyssey AR, Mini, Pro, Linear]

These set the envelope curvature to match the character of the selected vintage synth. Most should be self-explanatory; the others are explained below.

Custom enables the separate **Attack**, **Decay**, and **Release Curve** parameters as described below.

Mini is a classic American mono-synth.

Pro is a classic American 5-voice synth.

Linear sets all segments to have no curvature, which can be useful for specific purposes. For example, see “Tip: Curvature and Wavetable Position” on page 68.

Curve A, D, R (Attack, Decay, and Release Curves)

[0.0 (Linear), 0.1...9.9, 10.0 (exp/log)]

These parameters are available only if **Preset** is set to *Custom*. They set the curvatures of the **Attack**, **Decay**, and **Release** segments, respectively.

Tip: Different Curve settings for up and down

Generally, upwards segments use different **Curve** settings than downward segments. For instance, a **Curve** of 3.0 often works well for upward segments, such as **Attack**. On the other hand, a **Curve** of 6.0 or more is often better for downward segments, such as **Decay** and **Release**.

Envelope Curve

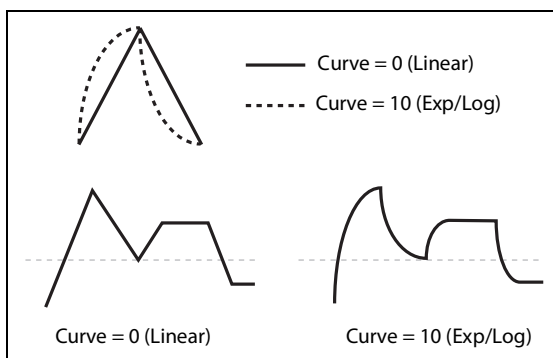

Tip: Curvature and Wavetable Position

When using an Envelope to modulate **Position** for Wavetable oscillators, curvature is a matter of taste, and results will vary depending on the contents of the Wavetable. A **Curve** of *0.0 (linear)* sweeps through the waveforms evenly, with equal time for each. A Curve of *10.0 (exp/log)* sweeps through the waveforms quickly at the start of the envelope segment, and much more slowly at the end of the segment.

Overshoot

[0...20]

In some vintage analog synthesizers, specific envelope signal might clip slightly, resulting in a flat top between the attack and decay segments. This “flat top” could be subtle, but would affect the perceived shape of the envelope. The width of the clipped portion would vary depending on the envelope’s attack and decay times. **Overshoot** models this behavior. At 0, there is no clipping; clipping then increases up to the maximum value of 20.

Filter A/Filter B/Pitch/Amp Envelope Trigger

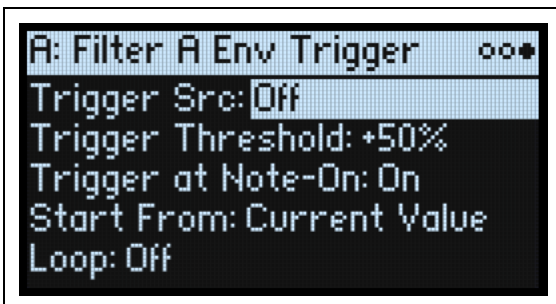

Trigger Src (Trigger Source)

[List of modulation sources]

This selects a source to start the envelope, or re-start it if it is already playing. For instance, you can use a tempo-synced LFO to trigger the envelope in a repeating rhythm, or create a looping envelope (see below).

Envelopes started or re-started by the **Trigger Source** work slightly differently from normal. The **Decay** always takes its full time, even if **Sustain** is at maximum; in this case, it acts as a hold time. Following the **Decay** time, the envelope goes to 0 over the **Release** time, even if the note is still being held.

Trigger Threshold

[-100%...+100%]

This sets the modulation level which will trigger the envelope. Among other things, you can use this to adjust the exact point in an LFO’s phase at which the envelope will be reset, effectively controlling its “groove” against other rhythmic effects.

When the threshold is *positive* (or 0), the envelope resets when the **Trigger Source** value passes through the threshold moving upwards. In other words, if the value has been below the **Threshold**, and then changes so that it is equal to or greater than the **Threshold**, the envelope resets.

When the threshold is *negative*, the envelope resets when the **Trigger Source** value passes through the threshold moving downwards. In other words, if the value has been above the **Threshold**, and then changes so that it is equal to or below the **Threshold**, the envelope resets.

Note: modulation sources may not always reliably reach the extreme values of +100 or -100. This can happen due to smoothing, or with LFOs when using certain shapes and faster speeds. If this is the case, **Thresholds** of +100 or -100 will cause inconsistent behavior. To avoid this issue, reduce the **Threshold** until the Envelope resets consistently.

Trigger at Note-On

[Off, On]

Trigger at Note-On is available for the Filter, Osc 1, and Osc 2 Envelopes. The Amp Envelope always triggers at note-on.

On: The envelope will start automatically at note-on. This is the default.

Off: The envelope will only start via the **Trigger Source**.

Envelopes

Note: The **Trigger Source's** value at note-on can cause the envelope to trigger instantly. If the **Threshold** is *positive* or *0*, this will happen if the value is at or above the **Threshold**; if the **Threshold** is *negative*, this will happen if the value is at or below the **Threshold**.

Tip: Looping Envelopes

You can use these controls to create a looping envelope which skips the Release segment (unlike the full Loop option below). To do so:

1. Set the Trigger Source to the same envelope that you're working with.

For example, if you're setting up the Filter Envelope, set the Trigger Source to the Filter Envelope.

2. Set the Trigger Threshold to -1.

3. Set the Sustain Level to -2.

Now, the envelope will re-start every time that it reaches the end of the Decay segment.

Loop

[Off, On]

Off: The envelope will play through the Decay phase and then hold at the Sustain Level until the note is released. When the note is released, it will enter the Release phase and then end. This is the default.

On: The envelope will not rest at the Sustain Level. Instead, as long as the note is held, it plays through the Release phase and then automatically starts again from the Delay Time. When the note is released, it will play through the Release phase one last time, and then end.

LFOs

Overview

LFOs create cyclical waveforms for use as a modulation source. For instance, you can:

- Select the LFO's basic waveform, and modify it with the Shape parameter.
- Control the LFO's frequency, or sync it to the system tempo.
- Use the **Fade** and **Delay** parameters to control how long the LFO waits to start after note-on, and whether it starts abruptly or fades in slowly.

Filter A, Filter B, Amp, Pitch, and PW/Morph LFO

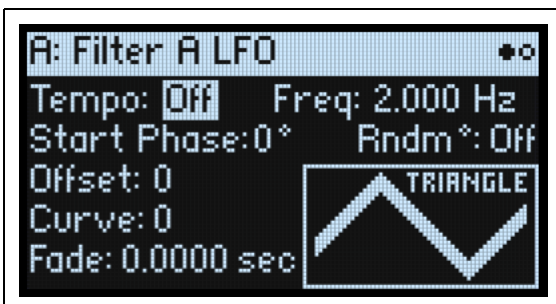

The five LFOs—Filter A, Filter B, Amp, Pitch, and PW/Morph—all work identically.

Tempo

[Off, On]

On: The LFO synchronizes to the system tempo, with its speed controlled by **Base Note** and **Multiply**.

Off: The LFO speed is controlled by the **Frequency** parameter, in Hz.

Base Note (FREQUENCY)

[List of rhythmic values]

If **Tempo** is *On*, this sets the basic speed of the LFO. The values range from a 32nd note to a double breve (four whole notes), including dotted notes and triplets.

x (Multiply Base Note by...)

[1...32]

If **Tempo** is *On*, this multiplies the length of the **Base Note**. For instance, if the **Base Note** is set to a sixteenth note, and **Times** is set to 3, the LFO will cycle over a dotted eighth note.

Freq (FREQUENCY)

[0.001...32.000 Hz]

If **Tempo** is *Off*, the LFO speed is set in Hz.

Waveform (WAVEFORM)

[Triangle...Rnd 6 (Continuous)]

This selects the LFO waveform, as shown in the graphic below.

Most of the waveforms are self-explanatory, but a few will benefit from more details:

GTR (Guitar) is intended for guitar vibrato. It is positive-only, so that when used for pitch, it only bends upwards.

RND 1 (Random 1) generates traditional sample and hold waveforms: random level changes with steady timing.

RND 2 (Random 2) randomizes both levels and timing.

RND 3 (Random 3) generates a pulse wave with random timing.

LFOs

RND 4-6 are smoothed versions of *Random 1-3*, with slopes instead of steps. Use them to create gentler random variations.

LFO Waveforms

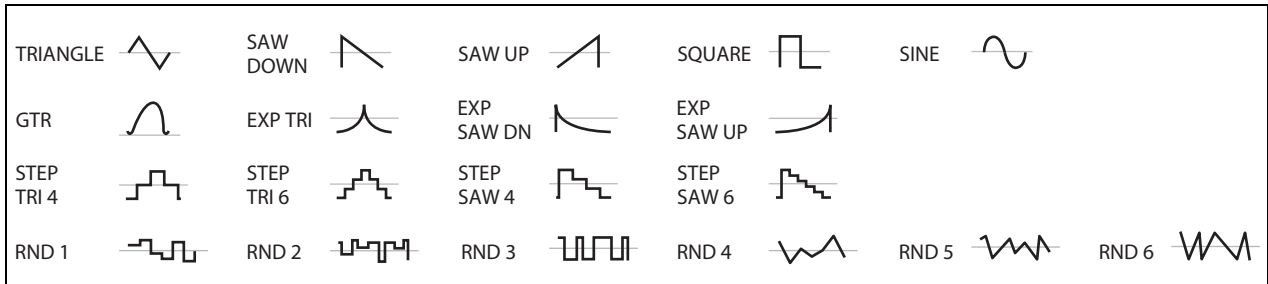

Start Phase

[-180...+180]

This controls the phase of the waveform when the LFO starts (see “When do Delay, Fade, Start Phase, and Random Phase apply?” on page 72). If **Random Start Phase** is *On*, or if one of the Random waveforms is selected, this parameter is not shown.

Rndm° (Random Start Phase)

[Off, On]

When **Random Start Phase** is *On*, the LFO will start at a different, random phase every time. If one of the Random waveforms is selected, this parameter is not shown.

Offset

[-100...+100]

By default, almost all of the LFO waveforms are centered around 0, and then swing all the way from -100 to +100. **Offset** lets you shift the LFO up and down, so that—for instance—it’s centered on 50, and then swings from -50 to +150.

For example, let’s say that you’re using an LFO for vibrato. If **Offset** is 0, the vibrato will be centered on the note’s original pitch, bending it both up and down.

If **Offset** is +100, on the other hand, the vibrato will only raise the pitch above the original note.

Offset settings and pitch change produced by vibrato

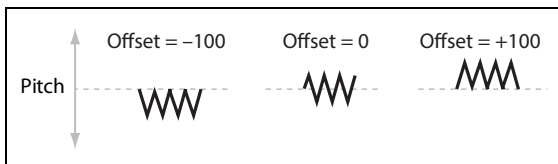

The one exception to this is the *Guitar* waveform, which is designed to emulate bending a string on a guitar—so that the pitch only goes up, and not down. Because of this, the waveform is centered on 50, and not on 0. Of course, you can always use a negative **Offset** to shift it back down below 0 again!

Offset affects the signal *after* the **Curve** function, as shown below:

LFO Signal Flow

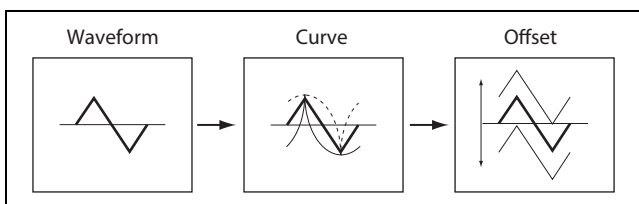

Curve (CURVE)

[-100...+100]

Curve adds curvature to the basic waveform. As you can see in the graphic below, this can make the waveforms either more rounded or more extreme. It can also be useful to emphasize certain value ranges, and deemphasize others.

LFOs

For example, let's say that you are using a triangle LFO to modulate filter cutoff. If **Curve** emphasizes the high value range, the filter will spend more time at the higher frequencies. If it emphasizes the low range, the filter will spend more time at the lower frequencies.

For control over whether the curve is *Asymmetric* or *Symmetric* around 0, see "Curve Mode" on page 73.

LFO Curve and Mode

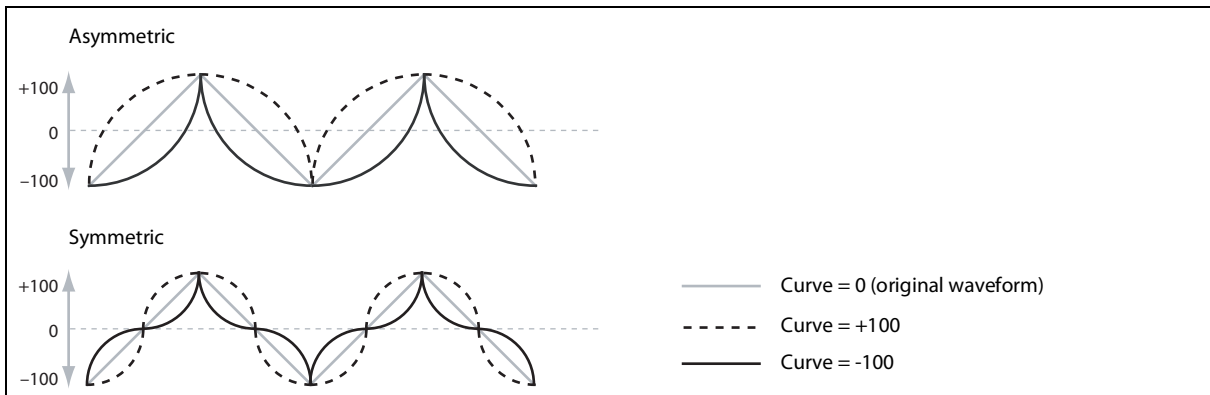

Note: **Curve** does *not* affect the *Square* and *Random 3* waveforms, since their values are always either +100 or -100.

Fade

[0.0000...9.9000 sec]

The LFO can fade in gradually, instead of starting immediately at full strength. This sets the time until the LFO reaches maximum amplitude. If **Delay** is used (see "Delay" on page 73), the **Fade** starts after the **Delay** is complete. See also "When do Delay, Fade, Start Phase, and Random Phase apply?" below.

SYNC NOTES

[Off, On]

This is controlled by the **SYNC NOTES** button.

Off: The LFO starts each time you press a key, and an independent LFO runs for each note. This is the default.

On: The LFOs for all notes in the Program will be synchronized together. See "Sync Notes Mode" on page 73.

When do Delay, Fade, Start Phase, and Random Phase apply?

Delay, Fade, Start Phase, and Random Phase apply when the LFO first starts (which depends on Sync Notes, as shown below), and when the LFO is reset via the **Trigger Source**.

Delay, Fade, Start/Random Phase, and Sync Notes

Sync Notes setting	Delay, Fade, Start Phase, and Random Phase apply at...
Off	Note-on
Sync Notes	First note in phrase
Free Run	Performance/Program selection, before any notes are played

Filter A, Filter B, Amp, Pitch, and PW/Morph LFO Details



Sync Notes Mode

[Sync Notes, Free Run]

This controls how the LFO behaves when **SYNC NOTES** is enabled.

Sync Notes: Each note has its own LFO. If no other notes are sounding, the LFO starts as it would normally. If other notes are sounding, the LFO starts by matching the phase of the oldest sounding note. The result is that the LFOs for all of the notes are initially synchronized together. This option is generally the most effective for synchronizing with tempo and Motion Sequences.

Note: With *Sync Notes*, each note's LFO speed may still be different if modulated by note number, velocity, key scaling, or other note-specific modulation sources.

Free Run: All notes in the Program share a single LFO. This is particularly useful if you want a slow LFO shape to continue running under multiple phrases, or under an arpeggiator pattern. The LFO starts running as soon as you select the Program or Performance, before any notes are played.

Curve Mode

[Symmetric, Asymmetric]

This controls the shape created by **Curve**; see "LFO Curve and Mode" on page 72.

Asymmetric produces a single curve, extending from -100 to +100.

Symmetric produces two matching curves extending outwards from 0 to -100 and +100, respectively.

For more information, see the similar feature in Mod Processor Curve, under "Mode" on page 79.

Delay

[0.0000...22.0000 sec]

This sets the time until the LFO starts. Depending on the **Sync Notes** settings, this may be the time from note-on, from the start of a phrase, or simply from the time that the sound is selected. It also applies when the LFO is triggered manually. For more information, see "When do Delay, Fade, Start Phase, and Random Phase apply?" on page 72. The **Fade** time begins after the **Delay** is complete.

Trigger

[Off, On]

This enables the **Trigger Source** below. The trigger resets the LFO to the **Start Phase**, and starts the **Delay** and **Fade** times.

Important: The **Trigger** settings apply only when **Sync Notes Mode** is set to *Free Run*, and **SYNC NOTES** is *On*.

On: The LFO will restart according to the **Trigger Source** and **Threshold** settings. This is the default.

Off: The **Trigger Source** will be ignored. This lets you quickly disable the function without having to set the **Trigger Source** to *None*.

Trigger Src (Trigger Source)

[List of modulation sources]

This selects a source to re-start the LFO from the **Start Phase**. For example, you can insert a MIDI CC trigger into a MIDI sequence so that a free-running LFO sounds the same every time the sequence is played.

You can also use *Gate + Damper* to reset the LFO at the start of phrases played on the keyboard. Note that this may not behave exactly the same as *Sync Notes*.

Trigger Threshold

[-100%...+100%]

This sets the modulation level which will trigger the LFO.

When the threshold is *positive* (or 0), the LFO resets when the value passes through the threshold moving upwards. In other words, if the value has been below the **Threshold**, and then changes so that it is equal to or greater than the **Threshold**, the LFO resets.

When the threshold is *negative*, the LFO resets when the value passes through the threshold moving downwards. In other words, if the value has been above the **Threshold**, and then changes so that it is equal to or below the **Threshold**, the LFO resets.

Note: modulation sources may not always reliably reach the extreme values of +100 or -100. This can happen due to smoothing, or with LFOs when using certain shapes and faster speeds. If this is the case, **Thresholds** of +100 or -100 will cause inconsistent behavior. To avoid this issue, reduce the **Threshold** until the LFO resets consistently.

Modulation Processors

Overview

Modulation Processors transform a modulation signal to make it into something new. The original modulation signal also remains available. There are six Modulation Processors per Program, plus two for the Performance as a whole.

The two Program Mod Processors can process any Channel, Performance, or Program modulation sources, but not voice-level signals such as Envelopes; they can modulate either per-voice or Program destinations (to modulate Effects, for example).

The four standard Mod Processors can process any modulation sources, but can modulate only voice-level destinations.

The two Performance Mod Processors can process only Channel and Performance-level modulation sources, but have the advantage of being able to modulate any destination, including Performance-level destinations such as the Arpeggiator.

The Modulation Processor outputs appear in the list of modulation sources, just like the LFOs and Envelopes.

To view and edit the Mod Processors, press **SHIFT-UTILITY**.

Type

[Gate, Offset, Quantize, Scale, Curve, Smooth, Sum]

This controls the type of processing performed by the Mod Processor. Each is described in detail below.

Gate

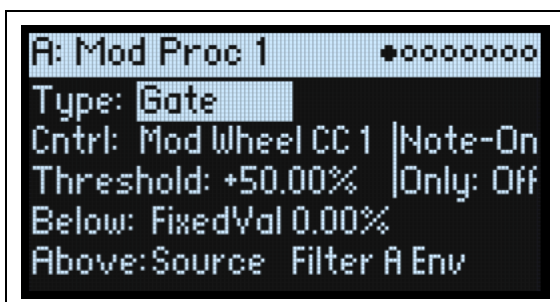

This lets you switch between two modulation sources (or fixed values) using a third modulation source.

It's similar to an audio gate with a side-chain, but with even more flexibility—since you get to choose what happens when the gate is closed (below the threshold), as well as when it's open (above the threshold).

For instance, you can use Gate to:

- Apply pitch-bend or other effects to some notes, but not to others (using **Control at Note-On Only**)
- Apply modulation only after the source reaches a certain threshold—for instance, use Velocity to modulate an LFO's frequency, but only once Velocity is greater than 90
- Use a controller to switch between two different LFOs (or any two modulation sources)

Cntrl (Control Source)

[List of Modulation Sources]

This selects the modulation source to control the Gate.

Threshold

[-100.00%...+100.00%]

This sets the value of the Control Source at which the gate opens or closes.

Control at Note-On Only

[Off, On]

When this is *On*, the value of the Control Source is only evaluated at note-on. The selected output will then remain active throughout the duration of the note, regardless of any subsequent change in the Control Source's value. Note that the output value itself can continue to change; only the selection of Below or Above is fixed.

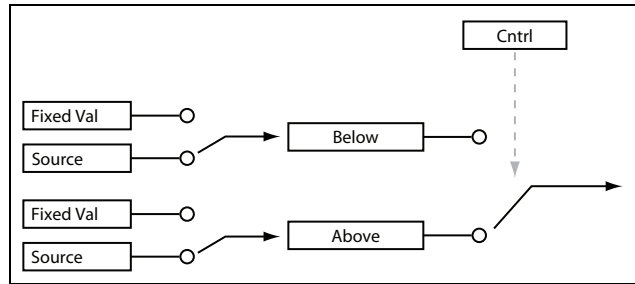

Below (Below Threshold)

[Fixed Val, Source]

This sets the output of the Gate when the Control Source is less than the **Threshold**. When this is set to *Fixed Val*, you can set a value between -100.00% and $+100.00\%$. When it is set to *Source*, you can select any modulation source.

Above (At & Above Threshold)

[Fixed Val, Source]

This sets the output of the Gate when the Control Source is equal to or greater than the **Threshold**.

Offset

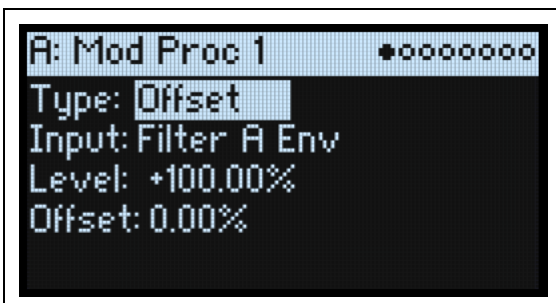

This adds a constant positive or negative offset to a modulation source, and also allows you to double the gain.

Input

[List of Modulation Sources]

This selects the input for the Mod Processor.

Level

[-200.00% ... $+200.00\%$]

$+200.00\%$ doubles the original signal level, while -200.00% doubles the level and inverts the phase.

Offset

[-200.00% ... $+200.00\%$]

This controls how the **Input** is shifted up or down.

$+200.00\%$ shifts an input of -100 all the way to $+100$.

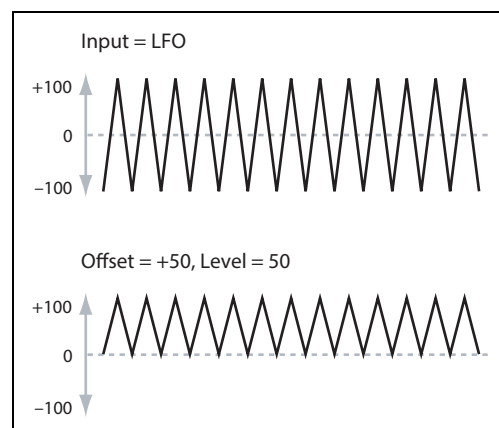

Converting from bipolar to unipolar

You can use *Offset* to convert a bipolar modulation source (both negative and positive), such as an LFO, to a unipolar signal (positive only). To do so:

1. Select the LFO as the source.
2. Set the Level to 50.00% .

This cuts the overall level of the LFO in half.

3. Set the Offset to 50.00% .

This shifts the LFO signal up, so that it now swings between 0 and $+100$.

Converting from unipolar to bipolar

Similarly, you can convert a unipolar modulation source to a bipolar signal:

1. Select the modulation source as desired.
2. Set the Level to +200.00%.

This doubles the overall level of the modulation source.

3. Set the Offset to -100.00%.

This shifts the Modulation signal down, so that it ranges from -100 to +100.

Quantize



This changes a continuous signal into a series of discrete steps. Use this to change the shape of LFOs or envelopes, or to force a controller to land on a few specific values.

Input

[List of Modulation Sources]

This selects the input for the Mod Processor.

Steps

[1...32]

This controls the severity of the effect. Lower values create more “steppy” effects.

For instance, when this is set to 2, there will be “steps” at 0, 50, and 100. With a bipolar source, there will also be steps at -50 and -100.

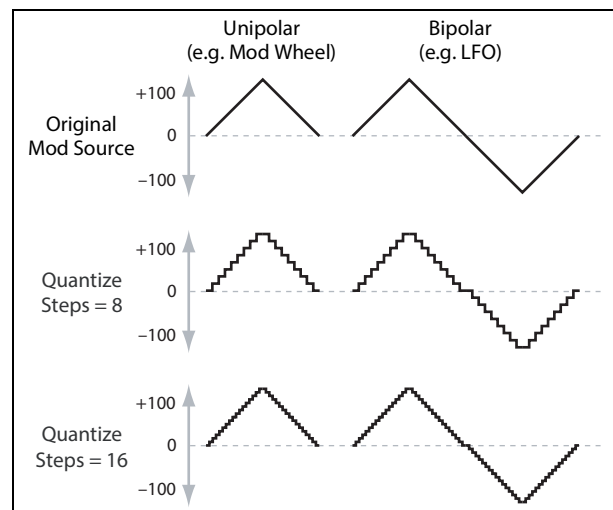

Quantized Pitch Bend

You can use Quantize to create quantized pitch bend, for fret-dragging effects, brass rips, and more.

1. Press the **PITCH** button, and select the **Tune** parameter.
2. Open the Add New Modulation popup (**MOD + >**), and press **ENTER** to set the Destination to *Pitch Tune*.
3. Press **ENTER** to close Add New Modulation and bring up the Modulation Source popup (since there isn't a front-panel control to select for Mod Processors).
4. Press the **PW/MORPH LFO** button to jump to the middle of the Generators section, and then scroll down to select *Prog ModProc 1*. Press **ENTER** to confirm.
5. Hold **ENTER** while moving the **VALUE** knob, and set the Intensity to any exact half-step value: +5.00, +7.00, etc.
6. Press **SHIFT + UTILITY** to go to the Mod Processor pages. Use **SHIFT + >** (**PAGE+**) to scroll to Prog Mod Proc 1 (Program Mod Processor 1).
7. Set Program Mod Processor 1's Type to *Quantize*, and set the Input to *Pitch Bend* (while the Modulation Source selector is on-screen, hold **ENTER** and move the Pitch Bend Wheel).
8. Set Steps to the same number you used for Intensity, above.
9. On the Common Pitch Mod page, set both Pitch Bend Up and Down to 0 (so that only the Mod Processor version will affect Pitch).

Now, moving the Pitch Bend wheel will create quantized pitch bends.

Scale



This processor uses a modulation source to scale the input. For instance, you can control the amount of an LFO with an Envelope, or control the amount of an Envelope with a MIDI controller.

Input

[List of Modulation Sources]

This selects the main input for the Mod Processor.

Main Input Amount

[−100.00%...+100.00%]

This controls the gain and polarity of the input signal, before being scaled by the **Scale Source**. Input from the **Scale Source** then adds to this initial amount.

Even if the **Main Input Amount** is set to 0, the **Scale Source** can still control the final amount of the Main Input over the full +/-100 range.

Scale Src (Scale Source)

[List of Modulation Sources]

This selects the modulation source to scale the **Input**.

Scale Src Amount (Scale Source Amount)

[−100.00%...+100.00%]

This controls the gain and polarity of the affect of the **Scale Source**. For example, the main input is an LFO and the **Scale Source** is an Envelope, positive settings mean that the Envelope will increase the amount the of LFO.

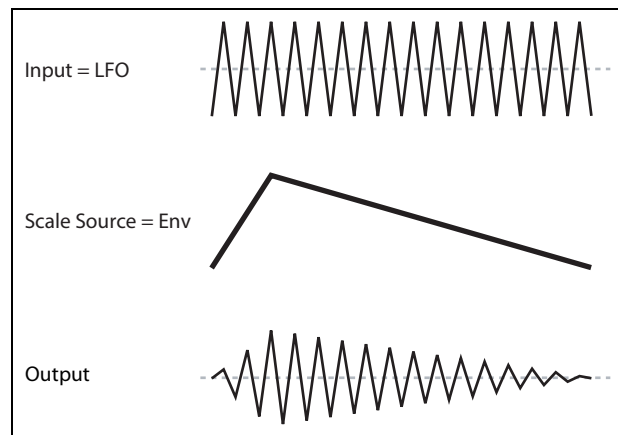

Curve

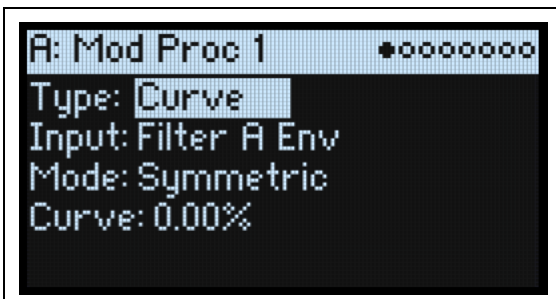

Curve can create custom controller curves, such as exponential wheels, logarithmic velocity, and so on. It can also alter the shape of programmable modulation sources, such as Envelopes and LFOs.

Note: Curve primarily affects modulation signals which already have some amount of slope, such as envelopes, triangle and sine LFOs, and so on. If the signal has only abrupt transitions from one value to another, like a classic sample-and-hold waveform, Curve will affect the values, but not the transitions between them. Curve does not affect signals which contain only maximum, 0, or minimum values, such as square waves.

Modulation Processors

Input

[List of Modulation Sources]

This selects the input for the Mod Processor.

Mode

[Symmetric, Asymmetric]

Asymmetric produces a single curve, extending from -100 to +100.

Symmetric produces two matching curves extending outwards from 0 to -100 and +100, respectively.

Curve and Mode

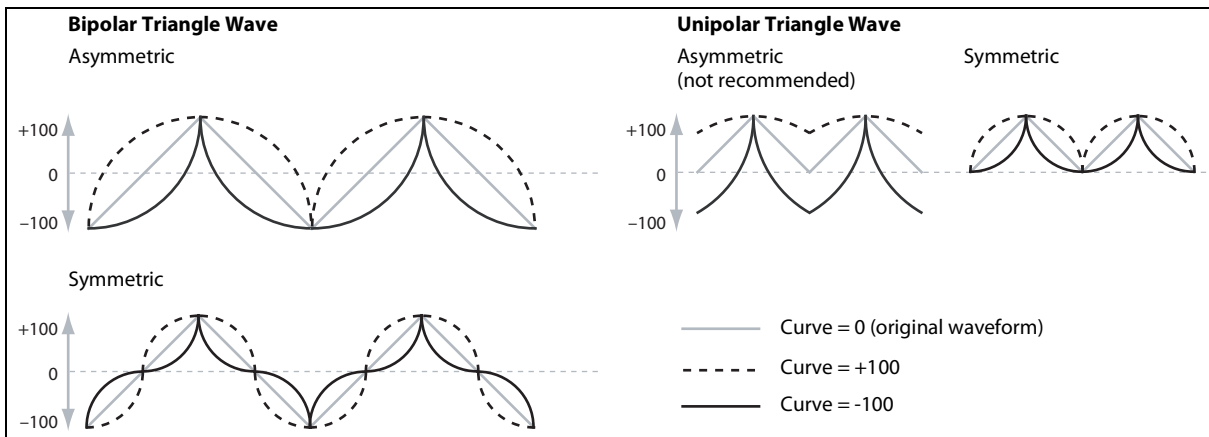

Curve

[-100.00%...+100.00%]

This controls the amount of curvature, and whether the curves are concave or convex.

As you can see in the graphic examples, the curve will emphasize certain value ranges, and deemphasize others. For example, let's say that you are using a triangle LFO, through Curve, to modulate filter cutoff. If Curve emphasizes high values, the filter will spend more time at higher frequencies. If it emphasizes low values, the filter will spend more time at lower frequencies.

Mode	Input	Curve	Result
Symmetric	Unipolar	Positive (+)	emphasizes upper value range
		Negative (-)	emphasizes lower value range
	Bipolar	Positive (+)	emphasizes both upper and lower value ranges, and deemphasizes the center
		Negative (-)	emphasizes center value range, around 0
Asymmetric	Unipolar	Positive (+)	emphasizes extreme upper range, with offset
		Negative (-)	emphasizes extreme lower range, with offset
	Bipolar	Positive (+)	emphasizes upper value range
		Negative (-)	emphasizes lower value range

Bipolar and Unipolar modulation sources

To understand Curve, it helps to understand the difference between *bipolar* and *unipolar* modulation sources.

Bipolar sources can swing all the way from -100 to +100, with 0 in the middle. Most LFOs are bipolar, for instance; so is Pitch Bend. Generally, bipolar modulation sources will work better with the *Asymmetric* mode, but *Symmetric* may also produce interesting results.

Unipolar sources only go from 0 to 100, with 50 in the middle. Often, MIDI controllers are unipolar (though you can also select bipolar versions). Envelopes are usually programmed to be unipolar, even though the Filter and Osc 1/2 Envelopes allow negative levels.

With unipolar sources, it's almost always better to use the *Symmetric* mode; *Asymmetric* can cause offsets and other strange results.

Smooth

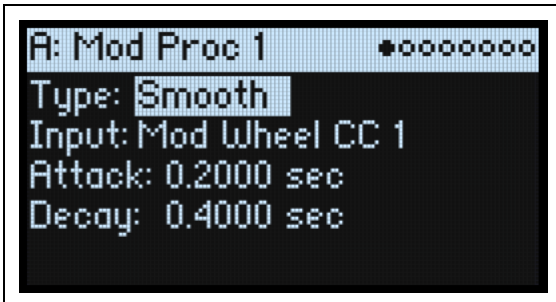

This creates more gentle transitions between values, smoothing out abrupt changes such as a quick move on a wheel or a sharp edge on an LFO.

You have separate control of the amount of smoothing during the attack (when the signal is increasing) and decay (when it's decreasing).

Low settings provide subtle controller smoothing, creating more gradual aftertouch, for instance. Higher settings create auto-fade effects, transforming a quick gesture into a longer fade-in and/or fade-out event.

Smoothing can also be used to alter the shape of programmable mod sources, such as LFOs and envelopes. For instance, you can turn a "blip" into a simple envelope shape, as shown below.

Input

[List of Modulation Sources]

This selects the input for the Mod Processor.

Attack

[0.0000... 10.0000 sec]

This controls how long it takes the smoother to reach a new, *higher* value. Higher settings mean longer times.

Decay

[0.0000... 10.0000 sec]

This controls how long it takes the smoother to reach a new, *lower* value. Higher settings mean longer times.

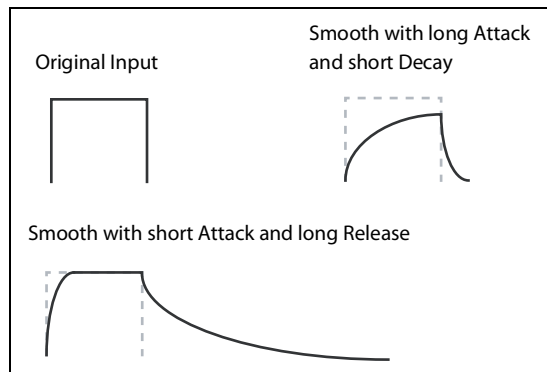

Sum

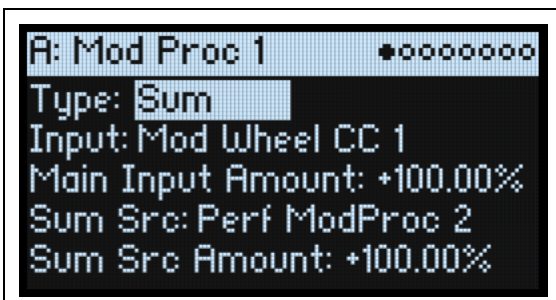

Sum adds two modulation sources together. This is useful if you want to process the combination of two or more signals: for instance, to merge an LFO and an envelope, and then smooth the result.

Modulation Processors

Input

[List of Modulation Sources]

This selects the main input for the Mod Processor.

Main Input Amount

[-100.00%...+100.00%]

This controls the gain and polarity of the **Input**.

Sum Src (Sum Source)

[List of Modulation Sources]

This selects the modulation source to merge into the **Input**.

Sum Src Amount (Sum Source Amount)

[-100.00%...+100.00%]

This controls the gain and polarity of the **Sum Source**.

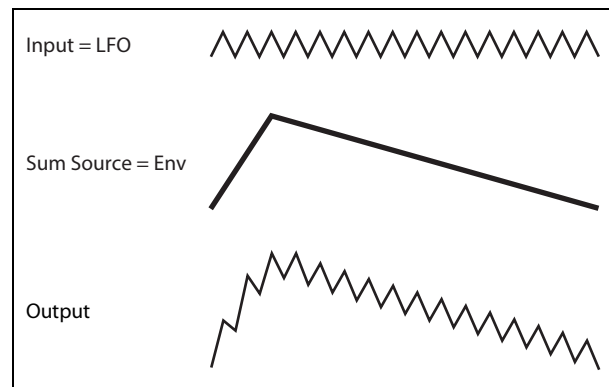

Motion Sequencing 2.0

What is Motion Sequencing 2.0?

Motion Sequencing 2.0 is evolved from the wavestate's Wave Sequencing 2.0. Sequences run individually for each voice. Timing, Pitch, Shape, and four sets of Step Sequence values (Seq A-D) are separated into "lanes." Each lane can have a different number of Steps, its own Loop Start and Loop End, and its own loop direction or step order randomization. Each Step in each Lane even has its own Probability.

Loop points, Step Probabilities, and other parameters in the lanes and their steps can be modulated on a per-note basis, using velocity, LFOs, envelopes, etc. Each time the sequence moves forward, values from the individual lanes are combined to create the output. The result can be either ever-changing rhythmic patterns or smooth, organic modulations.

You can easily record knob movements in real-time, enter pitch sequences from the keyboard, and constrain playback to a scale and key.

Motion Sequencing 2.0

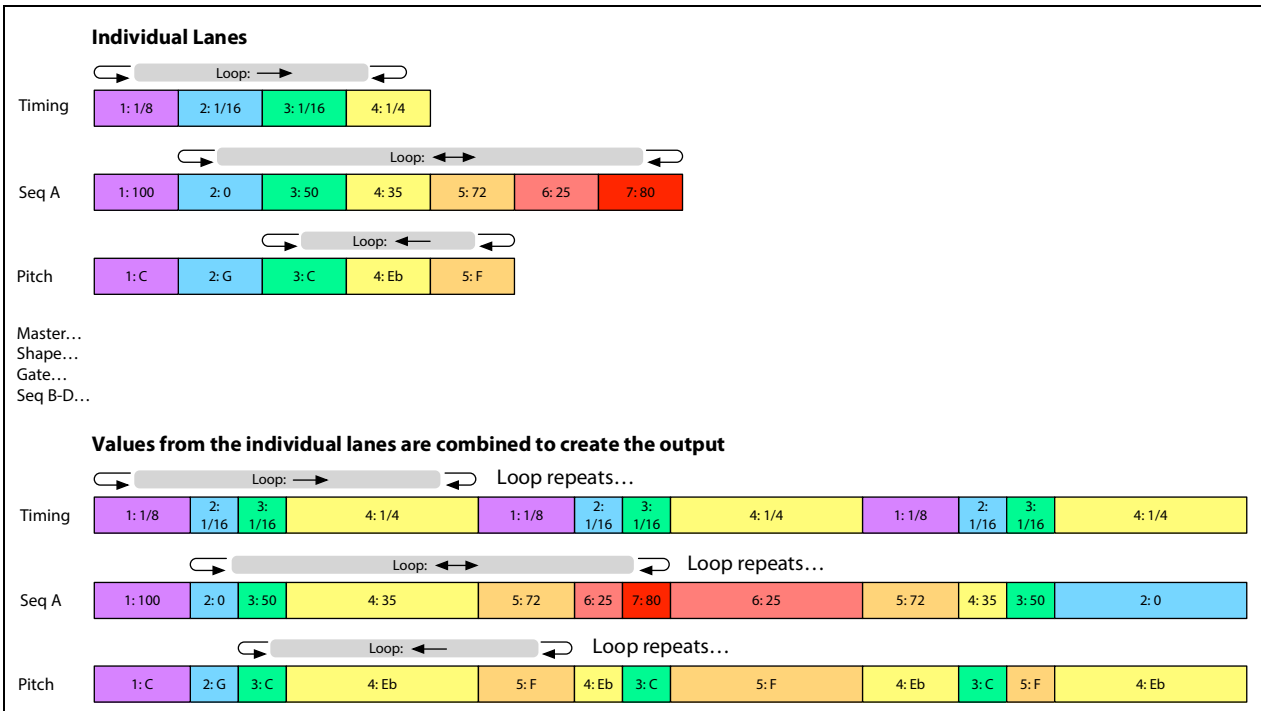

Motion Seq Overview

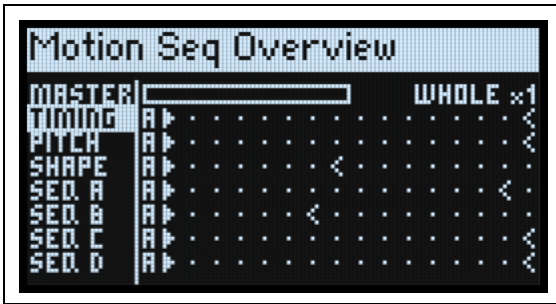

This shows all of the Motion Sequence Lanes for the Layer’s oldest sounding voice. It displays up to 16 steps at once, matching the 16 front-panel buttons, for each Layer. The bank, A/B/C/D, is shown to the left of the steps. For each lane, the display automatically shifts to show the bank containing the active step.

Note: Through modulation and probability, each voice in each Lane of each Motion Sequence may be on different steps, and may also have different Loop Start/Loop End settings.

Press **SHIFT-5 (SEQ VIEW)**, or just double-press **SEQ VIEW**, to go to this page.

The overview uses a few different symbols, as shown below. One detail bears mention: if both loops are on the same step, the Coincident Loop symbol is shown.

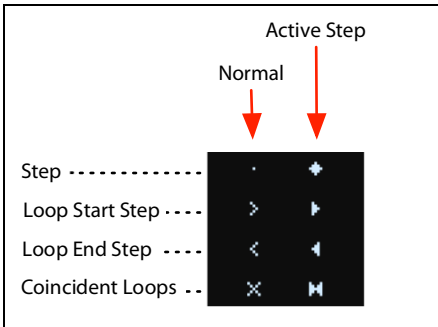

Master Lane Progress Bar

When enabled, the Master Lane restarts all of the other Lanes after either a specified number of beats or elapsed time; see “Master Lane” on page 88. The top-most line in the overview shows the current state of the Master Lane via a progress bar.

Motion Sequence Recording

Step recording Pitch

To record a sequence of notes into the Pitch lane:

1. Press **REC**.

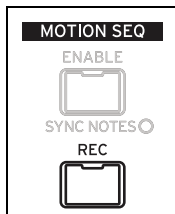

REC and buttons **11 (PITCH)** and **13-16 (SEQ A-D)** will blink.

2. Press button **11 (PITCH)** to select the Pitch Lane. Alternatively, press **REC** again to cancel.

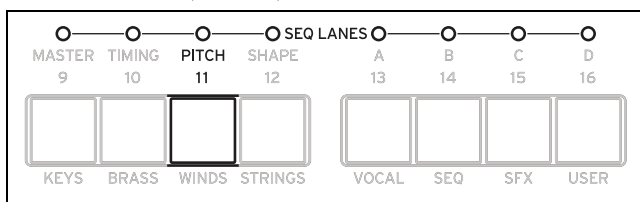

The Pitch Recording Setup page appears. Motion Sequence **ENABLE** is temporarily turned off, if it was on.

3. Play the root note for the key of the pitch sequence.

The Pitch lane stores offsets, instead of absolute pitches; those offsets will be calculated in relation to this root note. The default is C4. If you wish, you can also cursor to the on-screen parameter and enter a note using the **VALUE** knob.

You can record notes up to two octaves above and two octaves below the root note.

4. Set Clear as desired.

There are several options for clearing the previous contents of the Pitch Lane.

Steps & Lane Settings resets all of the Pitch Lane settings, such as Loop Start and Loop End, to their defaults. Any modulation routings to the Lane parameters will also be erased.

Step data only leaves the Pitch Lane settings intact, but resets all the individual Steps. Use this to retain previous settings for modulation, specific loop points, and so on.

Don't clear leaves all of the data intact. Use this to edit a few steps in a previously-created pitch sequence.

5. Press **ENTER** to begin recording.

The screen shows the pitch for the current Step. There's also a small read-only display of the previous step, to help keep your orientation when recording. The **Loop** graphic shows the current position in the loop. The Bank and Step button LEDs show the current step number.

After playing and releasing a note, recording automatically advances to the next step.

To go back to a previous step—to correct a mistake, for instance—press **<**.

To skip to the next step without changing the current step, press **>**.

The recording will automatically stop when the Loop End is reached. To end recording before then, press **REC** (or any key other than **<** and **>**).

Real-time recording for Seq Lanes A-D

You can record into Seq Lanes A-D in real-time, using either front panel knobs or the Mod Wheel. If you record a parameter knob, such as **MORPH**, the Seq Lane is automatically routed to modulate that parameter. After recording, you can edit the results, including the individual values in the Lane Steps and the intensity of the modulation routing. You can also route the Seq Lane to modulate additional parameters, using the normal Add Modulation process; see “Adding Modulation Routings” on page 59.

Important: The Motion Sequence runs independently per voice. This means that it can only modulate per-voice parameters, such as settings in the Oscillators, Filter, Envelopes, and LFOs. Specifically, the Motion Sequence cannot record or modulate the Mod Knobs, effects, or Kaoss Physics.

Motion Sequencing 2.0

Important: Loop modulation, random order, and note advance all apply during recording. For most deterministic use, use the option to Clear Steps & Lane Settings (see step 3 below), or disable these features manually!

1. Press REC.

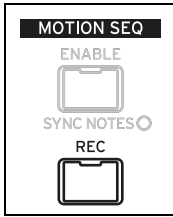

REC and buttons **11 (PITCH)** and **13-16 (SEQ A-D)** will blink.

2. Press one of buttons **13-16 (SEQ A-D)** to select a target Set Seq Lane. Alternatively, press REC again to cancel.

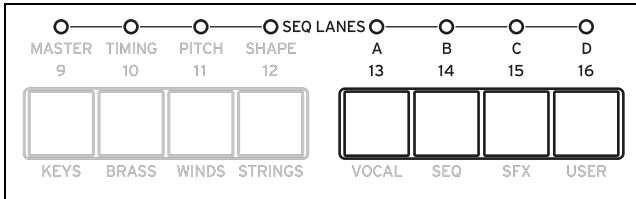

If there's already data in the selected Lane, you'll be prompted to clear the data.

3. If prompted, select an option for Clear, and then press ENTER to continue.

Steps & Lane Settings resets all of the Lane settings, such as Loop Start and Loop End, to their defaults. Any modulation routings to the Lane parameters will also be erased.

Step data only leaves the Lane settings intact, but resets all the individual Steps. Use this to retain previous settings for modulation, specific loop points, and so on.

4. When prompted by the display, play and hold a note.

Recording works best when playing a single note. Hold the note for the duration of the recording, either via the keyboard, the sustain pedal, or the **HOLD** button. If you release the note, or if the note's Amp Envelope reaches zero, recording will stop.

Once you play a note, the display changes to show the recording screen. The **Loop** graphic shows the current position in the loop.

5. To record, move a knob in the Oscillator, Filter, Envelope, or LFO sections, or move the Mod Wheel.

Once you move a knob or the Mod Wheel, recording starts. The **Knob** graphic shows the name of the knob being recorded, and **Value** shows the values being recorded. You'll see the **Loop** graphic begin to fill in, showing the section of the loop which has been recorded. You can start at any time during the loop; recording will wrap around if necessary. Once the entire loop has been recorded, recording stops automatically.

Recording a knob creates a modulation routing from the Seq Lane to the knob's parameter. (Recording the Mod Wheel records values only; modulation routings must then be created separately.) After recording, you can edit individual step values, change the intensity of the modulation routing, or create new modulation routings using the recorded Seq Lane as the source.

The initial position of the knob sets the "0" point. Moving the knob counter-clockwise goes from the current value to the minimum; moving clockwise goes from the current value to the maximum. If you turn the knob all the way to the left or right, the range is reset. See the graphic below.

Knob position and recorded values

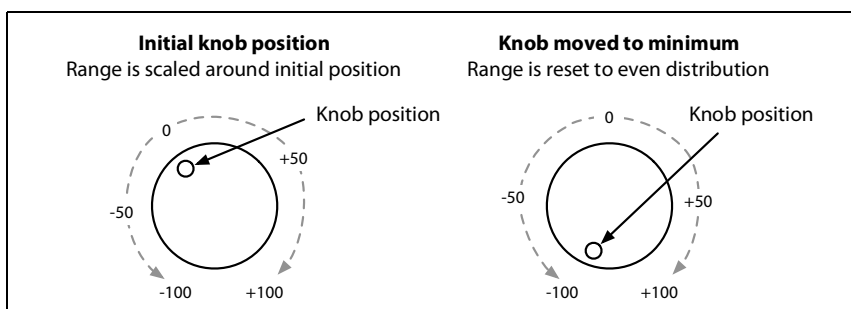

Other notes

- Only one knob can be recorded per Lane; if a second knob is moved during recording, it is ignored.
- The value is recorded at the end of the step.
- One value is recorded per step; for finer resolution in time, use a faster timing lane.
- For playback closest to the original knob movements, leave the Lane's **Transition** set to *Linear* (the default).

Motion Sequence editing

Editing Lanes

The Lane controls which of its Steps are played, and how they loop. Changing the **Loop Start** or **Loop End**, for instance, may significantly change the character of the sound; see “Standard Lane Controls” on page 89. Some Lanes have special parameters in addition to the standard controls, as described in the following sections.

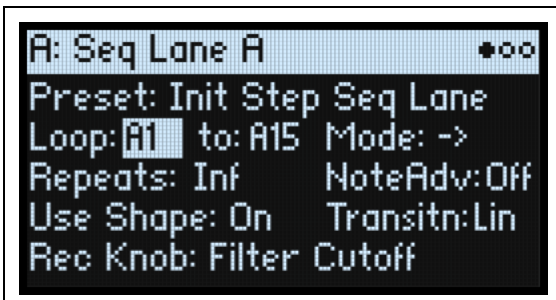

Editing Steps

There are up to 64 Steps per Lane, in four banks: A1-A16, B1-B16, etc. To view and edit individual Steps:

1. **Select the desired Lane by double-pressing one of buttons 10-16 (or holding SHIFT and pressing the button).** For example, to select Seq Lane A, double-press button 13.

2. **Press the SEQ STEPS button, so that it is lit.**

The 16 buttons at the bottom of the panel now select Steps. The current Step's LED is brightly lit; Steps within the programmed loop range (ignoring modulation) are also subtly illuminated.

3. **To select Steps in the current bank, press buttons 1-16.**

or:

To select from a different bank, double-press 1/2/3/4 to select the bank (you can also hold either SHIFT or SEQ STEPS and then press the button once). Buttons 1-16 will then blink; press one to select a Step in the new bank.

As you select different steps, the current parameter remains the same. For instance, if you are editing the Pitch for a number of steps, you can quickly select Steps in succession, editing the Pitch via the value knob.

4. **Edit as desired using the onscreen controls (cursor and VALUE knob).**

Step Solo mode

Step solo mode makes the Lane temporarily loop on the selected Step, for auditioning values or shapes, troubleshooting, etc.

To enter Step Solo mode:

1. **Hold ENTER and press a Step button.**

Both the Step button and the current Lane's button will blink.

The Motion Sequence will play as if that Lane was set to loop on the selected Step. Other Lanes will continue to play normally. If you select other Steps in the current Lane, solo will follow the selected Step.

To exit Step Solo mode, hold **ENTER** and press any Step button, or the current Lane's button.

Only one Lane at a time can be in Step Solo mode. If you enter Step Solo mode for a second Lane, the first Lane's Step Solo mode is turned off automatically. Changing to a different Layer also turns off Step Solo mode.

Motion Sequencer



This page lets you choose a Motion Sequence for the Program. Press **SEQ STEPS** to go to this page.

Preset (SEQ STEPS)

[List of Presets]

This list includes all of the Motion Sequence Presets stored in the database.

Enable (ENABLE)

[Off, On]

This turns the Motion Sequencer on and off for the current Layer.

Sync Notes (SYNC NOTES)

[Off, On]

Sync Notes sets whether individual notes play on their own separate timelines, or whether they are sync'd together.

Off: Each note's Motion Sequence will play independently.

On: If at least one note of the Program is already playing, the Motion Sequence lanes for newly played notes will start on the same steps as those of the oldest note. See the graphic below. There may still be variations due to per-note modulation or Probability.

Additionally, for all Layers which have both **SYNC NOTES** and **TEMPO** turned *On*, their Motion Sequences will sync together.

Sync Notes

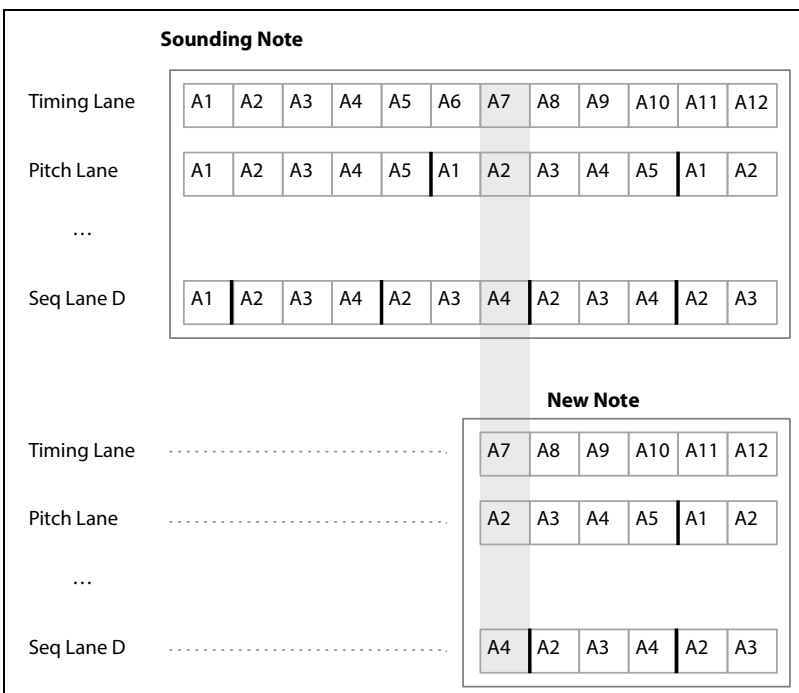
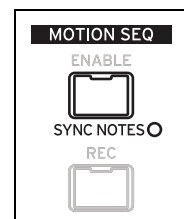

Use Master

[Off, On]

This enables the Master Lane; for more information, see “Master Lane” on page 88.

TEMPO (SHIFT-6)

[Off, On]

Tempo Off/On is stored in the Timing Lane; the parameter is duplicated here for convenience. For more information, see “TEMPO (SHIFT-6)” on page 90.

Master Lane



When **Use Master** is *On*, the Master Lane restarts all of the other Lanes after either a specified number of beats or elapsed time, depending on the **TEMPO** On/Off setting. You can use this to create regularly repeating patterns, even if the different Lanes all have irregular loop lengths.

Press **SHIFT-9 (MASTER)** to go to this page.

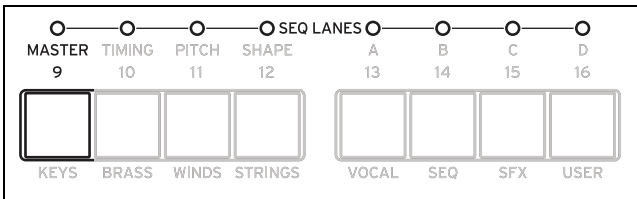

Use Master

[Off, On]

Off: The Master Lane is disabled.

On: The Master Lane is enabled, and restarts other Lanes as described above.

Loop Duration

[TEMPO Off: 0.0013...120.0000 seconds]

[TEMPO On: 32nd-note triplet...2x breve]

If Timing Lane **Tempo** is *Off*, you can set the length of the Master Lane loop in seconds.

If Timing Lane **Tempo** is *On*, this sets the basic length of the Master Lane, relative to the system tempo.

x (Multiply Base Note by...)

[1...32]

This appears only if **Tempo** is *On*. It multiplies the length of the **Base Note**. For instance, if the **Base Note** is set to a whole note, and **Times** is set to 3, the Master Lane will reset every three whole notes.

TEMPO (SHIFT-6)

[Off, On]

Tempo Off/On is stored in the Timing Lane; the parameter is duplicated here for convenience. For more information, see “TEMPO (SHIFT-6)” on page 90.

Standard Lane Controls

These controls apply to all lanes except Master.

Preset

Lane Presets store all of the parameters for the Lane and its Steps. Explore the system by mixing and matching presets for different Lanes.

Loop (Loop Start), to (Loop End)

These parameters control the Steps on which the Lane begins, ends, and loops. You can change them in real-time, while notes are sounding—and also modulate them via LFOs, Envelopes, etc.

🔊 If you want to modulate loop points, use these parameters to set the maximum loop length. **Loop Start** can only be modulated upwards, and **Loop End** can only be modulated downwards.

Mode

This controls the way that the Lane plays: Forward Loop, Backward Loop, alternating Forward-Backward Loop, or Random order. You can also enable Random order using the **RANDOM ORDER** button (**SHIFT-8**).

Repeats

[Off, 1... 100, Inf]

This controls the number of times that the Lane will loop. The default is *Inf*, which causes the loop to repeat as long as the note is held.

NoteAdv (NOTE ADVANCE, SHIFT-7)

When this is *On*, each note played will increment the Start Step by one. Try using this with the Arpeggiator!

RANDOM ORDER (SHIFT-8)

When this is *On*, the Steps will play in a different order every time the loop repeats.

To understand how **Random Order** works, imagine that each Step is on a note-card. Each time the loop plays, or whenever the **Loop Start** or **Loop End** changes, the note-cards from the **Loop Start** through the **Loop End** are shuffled and assigned to new numbers (A1, A2, etc.). Steps before the **Loop Start** and after the **Loop End** are ignored.

Step Probability

Each individual Step has a **Probability** setting, from 0% to 100%. This controls how likely the Step is to play. As with most Step parameters, **Probability** can be modulated; for instance, moving a Mod Knob might make some Steps more likely to occur, and other steps less likely to occur.

If a step has less than 100% **Probability** and loses the roll of the dice, as it were, it is skipped. (See note about the Timing Lane, below.) Since the Motion Sequence is generated in real-time, we need to avoid a situation in which we repeatedly roll the dice, lose the throw, and roll again and again; eventually, we need to make some sound! So, if two steps in a row are skipped, the third step always is played—even if its probability is 0%.

Timing Lane probability

The Timing Lane works slightly differently regarding probability: “skipped” steps are absorbed into the previous step. For instance, if A1 and A2 are both 16th notes, and A2 is skipped due to probability, A1 becomes an 8th note. This maintains the overall length of the rhythm.

Timing

This Lane controls the duration of each Step, creating rhythms or points on a timeline.

Timing Lane

Tempo On

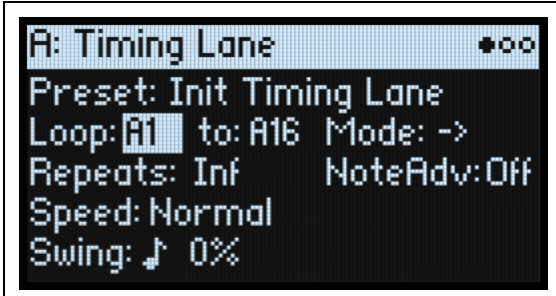

Tempo Off

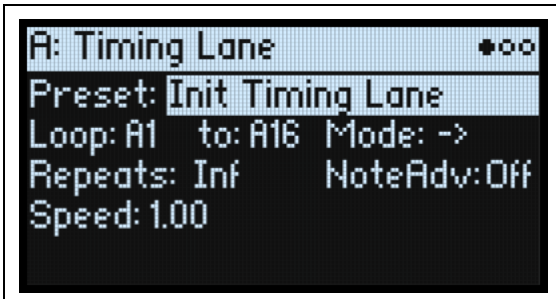

Press **SHIFT-10 (TIMING)** to go to this page.

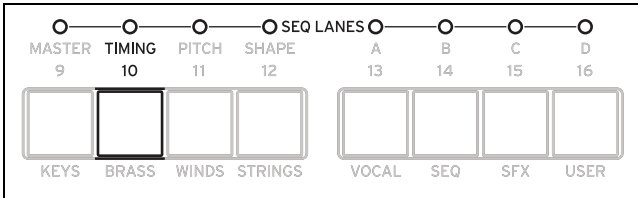

Preset, Loop (Start), to (Loop End), Mode, Repeats, NoteAdv

See “Standard Lane Controls” on page 89.

TEMPO (SHIFT-6)

[Off, On]

Off: Step **Durations** are specified in seconds.

On: Step **Durations** are specified in rhythmic values.

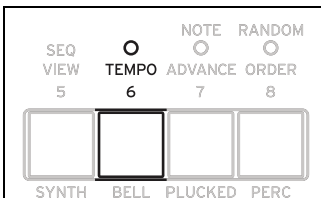

Speed

[TEMPO Off: 0.01...1.00...100.00]

[TEMPO On: 1/4...Normal...4x]

This modifies the speed of the entire Timing Lane. When **TEMPO** is *Off*, you can vary this continually from *0.01* (1/100 of the original speed) to *100.00* (100 times the original speed). Try modulating this from an envelope!

Motion Sequencing 2.0

When **TEMPO** is *On*, you can select tempo-locked ratios from $1/4$ to $4x$ of the original **Speed**.

Swing (Resolution)

[32nd-note triplet...quarter-note]

(Swing Amount)

[-300...+300%]

Swing adjusts the timing of up-beats relative to the Swing Resolution. For instance, if Resolution is set to $1/8$, Swing affects every other 8th note.

+100%: Full “swing.” Up-beats become triplets, moving one third of the way toward the next down-beat.

+300%: Up-beats move all the way to the next down-beat.

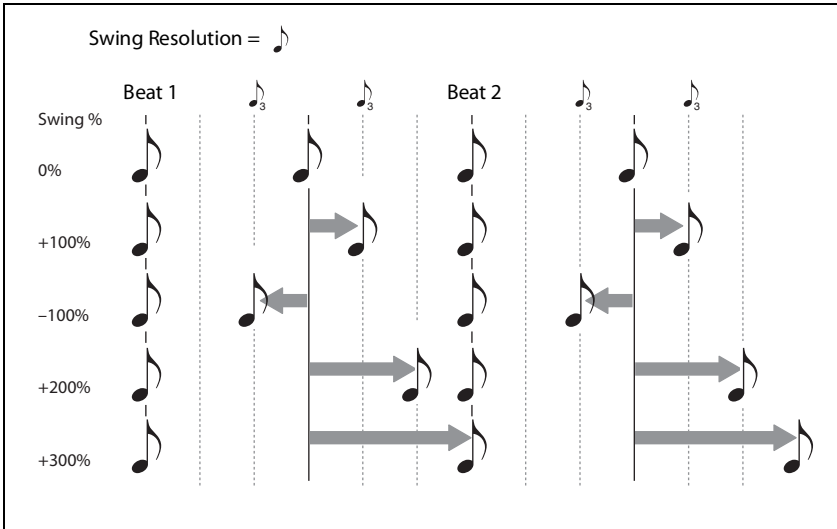

Timing Lane Step

Tempo On

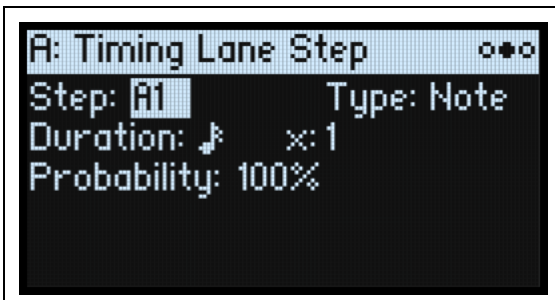

Tempo Off

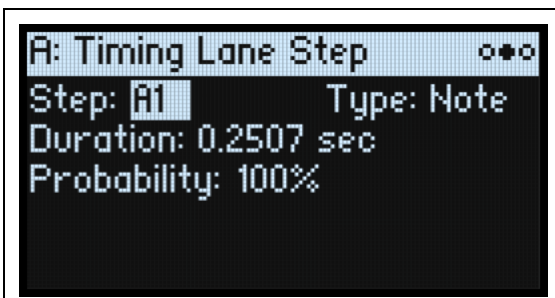

Step

[A1...D16]

This is the current Step. You can edit this parameter on-screen, or use the **SEQ STEP** buttons to select Steps directly.

Type

[Note, Rest, Gate]

Note: The step will play normally.

Rest: On *Rest Steps*, all Lane outputs are muted. Pitch and Seq Lanes A-D will output a value of zero, instead of the Step's programmed value.

Gate: The sequence will pause at the step until note-off, after which the sequence continues. If this is also the End Step, the Motion Sequence will stay on the step through note-off. By setting a single Timing Step to *Gate*, and then modulating the Lane Start Step by velocity, you can create a sound with up to 64 velocity switches. For instance, you can use this to switch between a large number of different Shapes.

Duration

[TEMPO Off: 0.0000...10.0000 seconds]

[TEMPO On: List of rhythmic values]

If **TEMPO** is *Off*, you can set the length of the step in seconds.

If **TEMPO** is *On*, you can set the basic length of the step as a rhythmic value, relative to the system tempo. The values range from a 32nd note to a double breve (four whole notes), including dotted notes and triplets. This length is then modified by **x (Multiply Base Note by...)**, below.

x (Multiply Base Note by...)

[1...32]

This appears only if **TEMPO** is *On*. It multiplies the length of the **Duration Base Note**. For instance, if the **Base Note** is set to an eighth note, and **Times** is set to 3, the step will last for a dotted quarter-note.

Probability

See "Step Probability" on page 89.

Pitch

This Lane sets the pitch of each Step.

Pitch Lane



Press **SHIFT-11 (PITCH)** to go to this page.

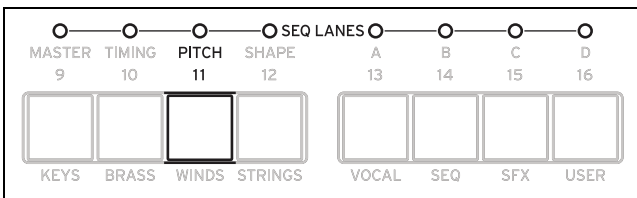

Preset, Loop (Start), to (Loop End), Mode, Repeats, NoteAdv

See "Standard Lane Controls" on page 89.

Use Shape

[Off, On]

When this is *On*, non-zero pitch values will be scaled by the Shape Lane. If the pitch offsets are zero, **Shape** has no effect. Note that **Shape** interacts with **Transition**, below; to hear Shapes unaltered, set **Transition** to *Off*.

Transitn (Transition)

[Off, Lin, Exp, Log, Indv]

This controls whether the pitch changes abruptly at each new step, or glides to the new value.

Off: Pitch will change abruptly at each step. This is the default.

Lin: The pitch will glide linearly from step to step.

Exp: The pitch will glide from step to step, with most of the change at the end of the glide.

Log: The pitch will glide from step to step, with most of the change at the start of the glide.

Indv (Individual): The pitch transitions will be controlled separately per Step. This lets you create melodic patterns which combine abrupt steps and glides, like a classic bass groove-box.

Fit to Scale

[Off, On]

This lets you constrain the Pitch Lane’s output to a specific scale and key—especially useful when playing polyphonically.

Off: Pitch offsets will be played exactly as they are entered in the sequence.

On: Pitches will be constrained to the specified scale and key.

(Scale Key)

[C...B]

This sets the root note of the scale. For instance, if Scale Key is set to E, and the Scale Type is set to Minor, all notes generated by the Pitch Lane will be confined to notes in the E Minor scale: E, F#, G, A, B, C, or D.

Scale Key only applies if **Fit To Scale** is *On*.

(Scale Type)

[Major, Minor, Hrmnic Maj, Hrmnic Min, Melodic Min, Dorian, Phrygian, Lydian, Mixolydian, Locrian, Penta Maj, Penta Min, Diminished, Half Dim, Augmented, Whole Tone, Tritone, Blues, Bebop Dom, Flamenco, Romani, Hungarian, Persian, Harmonics, Acoustic, Enigmatic]

This selects the scale to which the generated notes will be confined. It only applies if **Fit To Scale** is *On*.

	Notes generated by Pitch Lane (if Scale Key = C)											
Scale	C	C#	D	D#	E	F	F#	G	G#	A	A#	B
Major	C	C	D	E	E	F	G	G	A	A	B	B
Minor	C	C	D	D#	D#	F	G	G	G#	G#	A#	A#
HarmonicMajor	C	C	D	E	E	F	G	G	G#	G#	B	B
HarmonicMinor	C	C	D	D#	D#	F	G	G	G#	G#	B	B
MelodicMinor	C	C	D	D#	D#	F	G	G	A	A	B	B
Dorian	C	C	D	D#	D#	F	G	G	A	A	A#	A#
Phrygian	C	C#	D#	D#	F	F	G	G	G#	G#	A#	A#
Lydian	C	C	D	E	E	F#	F#	G	A	A	B	B
Mixolydian	C	C	D	E	E	F	G	G	A	A	A#	A#
Locrian	C	C#	D#	D#	F	F	F#	F#	G#	G#	A#	A#
MajorPentatonic	C	C	D	D	E	E	G	G	G	A	A	A
MinorPentatonic	C	C	D#	D#	D#	F	F	G	G	A#	A#	A#
Diminished	C	C	D	D#	D#	F	F#	F#	G#	A	A	B
HalfDiminished	C	C	D	D#	F	F	F#	F#	G#	G#	A#	A#
Augmented	C	C	D#	D#	E	E	G	G	G#	G#	B	B
WholeTone	C	C	D	E	E	F#	F#	G#	G#	A#	A#	A#

Motion Sequencing 2.0

Tritone	C	C#	C#	E	E	F#	F#	G	G	A#	A#	A#
BluesScale	C	C	D#	D#	D#	F	F#	G	G	A#	A#	A#
BebopDominant	C	C	D	E	E	F	G	G	A	A	A#	B
Flamenco	C	C#	C#	E	E	F	G	G	G#	G#	B	B
Romani	C	C	D	D#	D#	F#	F#	G	G#	G#	A#	A#
HungarianMinor	C	C	D	D#	D#	F#	F#	G	G#	G#	B	B
Persian	C	C#	C#	E	E	F	F#	F#	G#	G#	B	B
Harmonics	C	C	D#	D#	E	F	G	G	G	A	A	A
Acoustic	C	C	D	E	E	F#	F#	G	A	A	A#	A#
Enigmatic	C	C#	C#	E	E	F#	F#	G#	G#	A#	B	B

Pitch Lane Step



Step

See “Step” on page 91.

Transpose

[-24...+24 semitones]

This offsets the played note by up to two octaves, up or down.

Tune

[-12.00...+12.00 semitones]

This changes the tuning by up to one octave up or down.

Transition

[Off, Lin, Exp, Log]

This controls the transition from *this* step to the *next* step: whether the pitch changes abruptly at the *next* step, or glides to the new value.

 This applies only if the Pitch Lane **Transitn** parameter is set to *Indv* (Individual).

Off: The pitch will change abruptly at the next step. This is the default.

Lin: The pitch will glide linearly to the next step.

Exp: The pitch will glide to the next step, with most of the change at the end of the glide.

Log: The pitch will glide to the next step, with most of the change at the start of the glide.

Probability

See “Step Probability” on page 89.

Shape

The Shape Lane creates a contour over the duration of the step. It can affect the Pitch Lane and/or any of the Seq Lanes (when the respective Lane's **Use Shape** is *On*).

Shape Lane

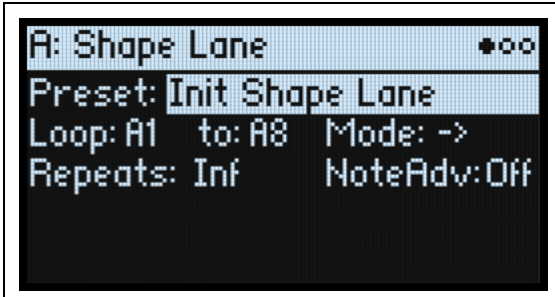

Press **SHIFT-12 (SHAPE)** to go to this page.

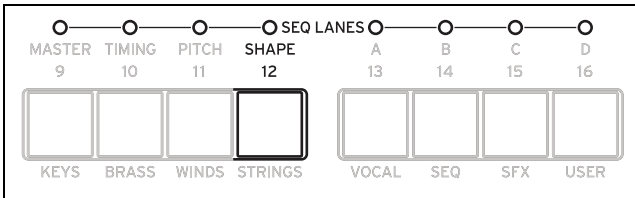

Preset, Loop (Start), to (Loop End), Mode, Repeats, NoteAdv

See "Standard Lane Controls" on page 89.

Shape Lane Step

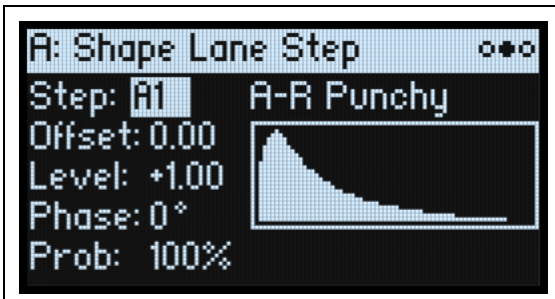

Step

See "Step" on page 91.

Shape

[List of shapes]

There are a large number of shapes to choose from, including ones with two, three, or four pulses.

Offset

[-1.00...+1.00]

This shifts the entire shape up or down. It works slightly differently from Mod Processor "Offset," in that the **Offset** is added to the shape, and then the result is scaled by the **Level**, below. For instance, if you want the bottom of the Shape to be 0.50 instead of 0.0, set **Offset** to +1.00 and **Level** to +0.50.

Level

[-2.00...+2.00]

This varies the amplitude of the Shape. Negative values invert the shape.

Phase

[-180...+180°]

This controls the start point of the shape. For example, to start in the middle of the shape, set the Phase to +180°.

Prob (Probability)

See “Step Probability” on page 89.

Seq A/B/C/D

The four Seq Lanes generate modulation sources to control other synthesis parameters, just like envelopes, LFOs, etc.

Seq Lane

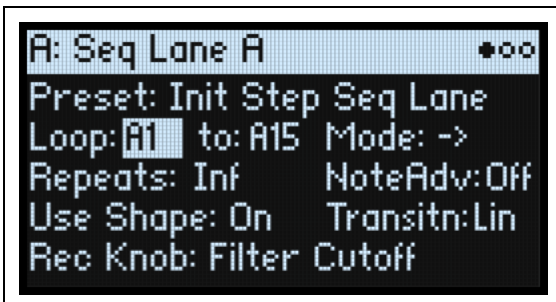

Press **SHIFT-13...16 (SEQ A...D)** to go to this page.

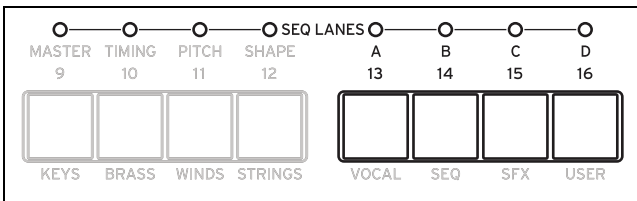

Preset, Loop (Start), to (Loop End), Mode, Repeats, NoteAdv

See “Standard Lane Controls” on page 89.

Use Shape

[Off, On]

When this is *On*, non-zero values will be scaled by the Shape Lane. Note that **Shape** interacts with **Transition**, below; to hear Shapes unaltered, set **Transition** to *Off*.

Transitr (Transition)

[Off, Lin, Exp, Log, Indv]

This controls whether the value changes abruptly at each new step, or glides to the new value.

Off: Values will change abruptly at each step.

Lin: Values will glide linearly from step to step, as if you were moving a knob continuously. This is the default.

Exp: Values will glide from step to step, with most of the change at the end of the glide.

Log: Values will glide from step to step, with most of the change at the start of the glide.

Indv (Individual): Transitions will be controlled separately per Step. This lets you create complex patterns which combine abrupt steps and glides.

Rec Knob

[Knob name, read-only]

If the Seq Lane was created by real-time recording, this shows the name of the parameter that was recorded. (See “Real-time recording for Seq Lanes A-D” on page 84.) Otherwise, it shows *None*. This value is read-only, and cannot be edited. Note that the Seq Lane may be modulating other parameters as well, and that the modulation routing to the recorded knob may be changed or even deleted entirely.

Seq Lane Step



Step

[A1...D16]

See “Step” on page 91.

Type

[**Value + Continuous Mod**, **Value * Random +/-**, **Value * Random +**, **Value + S & H Mod**]

Value + Continuous Mod: The Step uses the programmed value, and modulation continuously affects the value. For instance, if an LFO is modulating **Value**, you’ll hear the LFO’s shape during the step.

*Value * Random +/-*: The Step’s **Value** is scaled by a bipolar random amount. The result may be either positive or negative.

*Value * Random +*: The Step’s **Value** is scaled by a unipolar random amount. If the **Value** is positive, the output will be positive; if the **Value** is negative, the output will be negative.

Value + S & H Mod: The Step uses the programmed value, and modulation is updated only at the start of the Step. For instance, if an LFO is modulating **Value**, only the LFO’s amplitude at the very start of the step matters; you will **not** hear the LFO’s shape during the step.

Value

[-100...100%]

This sets the output level for the Step.

Transition

[Off, Lin, Exp, Log]

This controls the transition from *this* step to the *next* step: whether the value changes abruptly at the *next* step, or glides to the new level.

 This applies only if the Seq Lane **Transitn** parameter is set to *Indv* (Individual).

Off: The value will change abruptly at the next step.

Lin: The value will glide linearly to the next step, as if you were moving a knob continuously. This is the default.

Exp: The value will glide to the next step, with most of the change at the end of the glide.

Log: The value will glide to the next step, with most of the change at the start of the glide.

Probability

See “Step Probability” on page 89.

Motion Sequence Utility

Cut Steps, Copy Steps, Paste Steps, Insert Steps

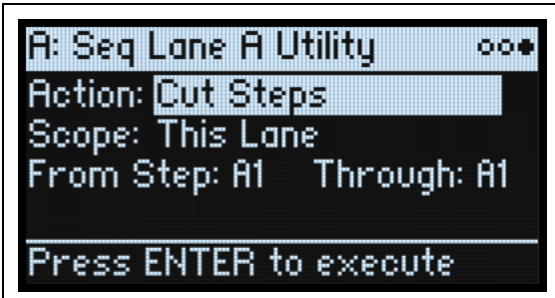

To cut, copy, paste, or insert Steps to either a single Lane or all Lanes:

1. From a Motion Sequence Lane page, use **PAGE+** to go to the Lane Utility page.
2. Select an Action such as Cut Steps or Insert Steps.
3. Set the Scope as desired, to apply the Action to all Lanes or to only the current Lane.
4. Set the other parameters (From Step, Through, etc.) as desired.
5. Press **ENTER** to execute the command.

Clear

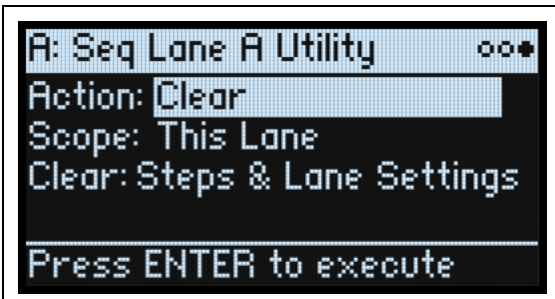

This Action allows you to reset either a single Lane or all Lanes to their defaults. There are two choices for what to clear:

Steps & Lane Settings resets all of the Step data and all of the Lane parameters, such as Loop Start and Loop End, to their defaults. Any modulation routings to the Lane parameters will also be erased.

Step data only will leave the Lane settings intact, but reset all the individual Steps. Use this to retain previous settings for modulation, specific loop points, and so on.

To use Clear, follow the general instructions under “Cut Steps, Copy Steps, Paste Steps, Insert Steps,” above, selecting Clear as the Action.

Scale Timing

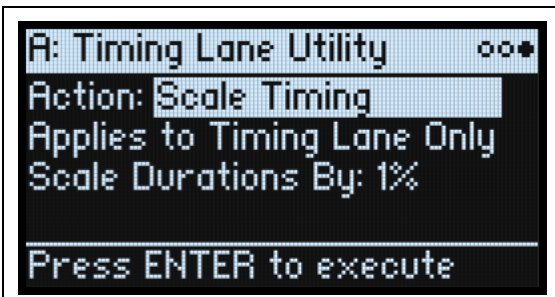

This Action is available only when entering the Motion Sequence Utility page via the Timing Lane. It allows you to edit all of the Timing Lane Step Durations at once, to make the sequence longer or shorter. If you want to change this in real-time, use the Timing Lane **Speed** parameter instead.

Kaoss Physics

Overview

Kaoss Physics models a ball rolling on a surface. You can start the ball by flicking a finger on the x-y pad, or launch the ball automatically using a trigger source such as *Gate + Damper*. You can also directly control the ball by holding your finger on the pad. The position of the ball produces several modulation signals (which can be used to control any modulation destination):

- *Kaoss X* is the horizontal position of the ball: negative to the left of center, 0 in the middle, and positive to the right.
- *Kaoss Y* is the vertical position: negative below the center, 0 in the middle, and positive above the center.
- *Kaoss Distance* is the distance from the center, which is always positive.
- *Kaoss Angle* is the current angle of the ball relative to the x axis. The value is always positive, regardless of whether it is above or below the x axis.

Kaoss Angle

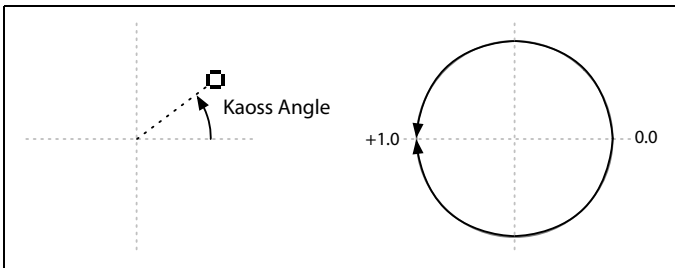

There is a bump in the surface, going either down or up, like a hole or a hill. You can set the height or depth of the bump, and choose one of several different shapes for its slopes. The surface has adjustable friction, so that the ball slows down as it travels. There are walls on the four sides of the surface, and when the ball hits a wall, it bounces off. Walls can slow down the ball, as if they were padded, or accelerate the ball, like bumpers in a pinball machine. The walls can also be removed entirely, so that the surface wraps around to the opposite edges like a vintage arcade game.

Note that most parameters, including **Tilt**, **Friction**, **Time**, **Bump Height** and **Position**, etc. are modulatable. You can even modulate them from the Kaoss Physics outputs—for instance, try modulating **Tilt X** with *Kaoss Y*.

Using Kaoss Physics to create specific results

Kaoss Physics can be interesting in itself, but you can also use it to create specific modulation effects. For instance:

- Use a centered **Bump** with negative **Height** so that the modulation values always eventually return to 0
- Position a **Bump** with positive **Height** on a side or a corner, to push modulation values *away* from that zone
- Set up opposing edges (top and bottom, and/or left and right) so that one has positive **Bounce** and the other has negative **Bounce**, so that the ball repeatedly speeds up and slows down
- Use **Friction** to slow down the ball over time, so that movement ends gradually and naturally
- Use the different forces—**Tilt**, **Friction**, **Bump Height**, and **Bounce**—to oppose and balance one another

Kaoss Physics and MIDI

When you move your finger on the x-y pad, the X and Y positions are sent as two MIDI CCs (18 and 19 by default), and a third CC (20 by default) indicates that your finger is on the pad. When you lift your finger off of the x-y pad to “throw” the ball, the third CC (20 by default) indicates that the finger is no longer on the pad, and the release position, direction, and velocity of the throw are sent in high resolution via a set of six additional CCs (105-110 by default).

When these MIDI messages are received, they’re processed by Kaoss Physics as if you were playing live on the x-y pad. Note that the movement of the ball is not directly transmitted or received.

To change the Kaoss Physics CC assignments, see See “MIDI CC Assign” on page 120.

Kaoss Physics

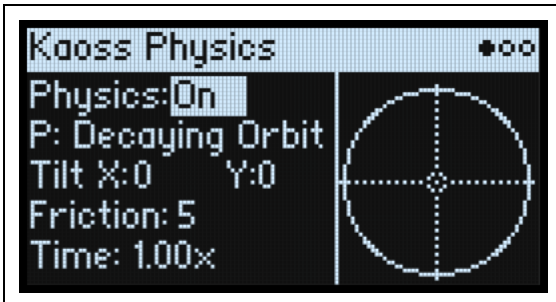

Physics (SHIFT- KAOSS)

[Off, On]

Off: The physics model is disabled, and the pad works as a simple x-y pad.

On: The physics model is enabled.

Hold Position

[Off, On]

When **Physics** is *Off*, the physics model is disabled, and the pad works as a simple x-y pad (although **Lag Time** still applies). In this mode, other parameters (such as the **Kaoss Physics Preset**) are hidden, and **Hold Position** determines what happens when you let go of the ball.

Off: The ball snaps back to the center.

On: The ball remains where it was placed.

P (Kaoss Physics Preset)

[List of Presets]

Select the parameter and then either turn the **VALUE** knob or press **ENTER** to bring up the Preset Select popup, which shows all of the Kaoss Physics Presets installed on the instrument. For details on sorting and filtering the list, see “Selecting from lists” on page 4.

Tilt X

[-100...+100]

Tilts the plane from left (negative) to right (positive).

Tilt Y

[-100...+100]

Tilts the plane from down (negative) to up (positive). For instance, tilting Y downward creates “gravity” towards the bottom.

Friction

[0...100]

Controls the energy absorption as the ball travels across the surface.

Time

[0.00x...1.00x]

Slows down time. Note that 1.00 (normal speed) is the maximum; if you want to both speed up and slow down, start at a value in the middle.

Kaoss Physics Details

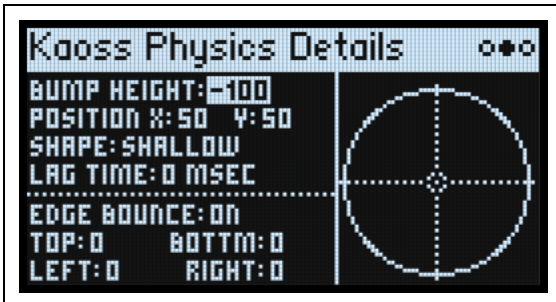

Bump Height

[-100...+100]

Positive for convex (a “hill”), negative for concave (a “hole”).

Position X

[0...50...100]

Sets the center point of the bump on the X axis. 50 is the center; 0 is the left side, and 100 is the right.

(Position) Y

[0...50...100]

Sets the center point of the bump on the Y axis. 50 is the center; 0 is the bottom, and 100 is the top.

Shape

[Gravity, Linear, Shallow, Steep]

Shape controls the slope from the edges of the surface to the center point.

Gravity: The closer to the center, the steeper the slope. With negative Bump Heights, this acts similar to gravitational attraction.

Linear: Slope is constant over the entire surface.

Shallow: Slope is steep close to the edges and more gentle in the middle, like a shallow bowl.

Steep: Slope is gentle over most of the surface and markedly stronger in the center.

Lag Time

[0 msec...10 sec]

This controls a set of lag filters which smooth out the modulation values generated by Kaoss Physics.

0 msec is the default; the modulation values directly represent the movement of the ball.

Higher values create increasingly gentle transitions between values, smoothing out abrupt changes.

Note: **Lag Time** affects only the Kaoss Physics modulation outputs, rather than the motion of the ball.

Edge Bounce

[Off, On]

Off: This removes the walls entirely, so that the surface wraps around to the opposite edges like a vintage arcade game.

On: The ball bounces off of the four walls as specified below.

(Edge Bounce) Top/Bottom/Left/Right

[-100...+100]

These four parameters control what happens when the ball hits each of the walls. They only apply if **Edge Bounce** is *On*.

Negative values slow down the ball, as if the wall was padded.

Positive values accelerate the ball, like bumpers in a pinball machine.

Kaoss Launch

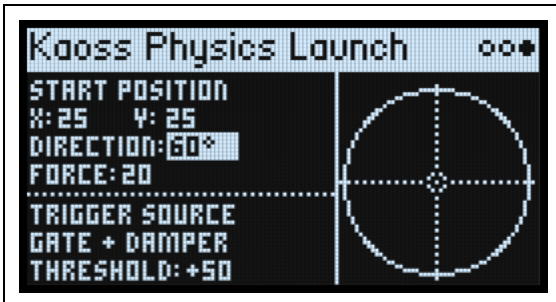

This page lets you launch the ball automatically using a trigger source. For instance, triggering via *Gate + Damper* will launch the ball whenever you play a new phrase on the keyboard; triggering via the *Kaoss Button* will launch the ball when you press the front-panel **KAOSS** button. You can control the start point, direction, and force of the launch.

Start Position X

[0...50...100]

Sets the start point of the launch on the X axis. 50 is the center; 0 is the left side, and 100 is the right.

(Start Position) Y

[0...50...100]

Sets the start point of the launch on the Y axis. 50 is the center; 0 is the bottom, and 100 is the top.

Direction

[0...360°]

This controls the angle of the launch. 0° (and 360°) is straight to the right, 90° is straight up, 180° is straight to the left, and 270° is straight down.

Force

[0...100]

This controls the initial speed of the ball.

Trigger Source

[List of modulation sources]

This selects a source to trigger the launch. Try using *Gate + Damper* or *Kaoss Button*. Note that since there is a single Kaoss Physics generator for the entire Performance, per-voice sources such as Envelopes and LFOs cannot be used as triggers.

Trigger Threshold

[-100%...+100%]

This sets the modulation level which will trigger the launch. With either *Gate + Damper* or *Kaoss Button* as the source, use a positive value of 50%.

When the threshold is *positive* (or 0), the launch triggers when passing through the threshold moving upwards. In other words, if the value has been below the **Threshold**, and then changes so that it is equal to or greater than the **Threshold**, the ball is launched.

When the threshold is *negative*, the launch triggers when passing through the threshold moving downwards. In other words, if the value has been above the **Threshold**, and then changes so that it is equal to or less than the **Threshold**, the ball is launched.

Arpeggiator

Arpeggiator



The Arpeggiator is particularly effective in conjunction with Motion Sequence Lane **Note Advance**, so that each generated note starts on a new step in the Lane. Try this with a single Timing step set to *Gate*.

Arpeggiator (ARPEGGIATOR)

[Off, On]

To turn the arpeggiator on and off from the front panel, **SHIFT**-press or double-press the **ARPEGGIATOR** button.

Pattern

[Up, Down, Alt1, Alt2, Random]

This controls the note pattern of the Arpeggiator. Most should be self-explanatory. *Alt1* and *Alt2* each go up and then down; the difference between them is that *Alt2* plays the top-most and bottom-most notes twice.

Up



Down



Alt1



Alt2

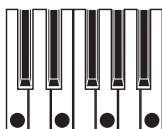

Arpeggiator

Random

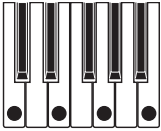

Resolution

[32nd note triplet ... 1/4 note]

This controls the speed of the Arpeggiator. Try modulating this from the Mod Wheel!

Swing

[-100%...+100%]

This controls the rhythmic swing of the Arpeggiator, based on the **Resolution** above.

100%: The second rhythmic division will be pushed to the third triplet, for a full swing feel.

-100%: The second rhythmic division will be pulled to the second triplet, for a reverse-swing feel.

Octaves

[1...4]

This controls the range of the arpeggiated notes. 1 uses the pitches as played. 2-4 transpose upwards by the specified number of octaves.

Sort

[Off, On]

Off: The Arpeggiator **Patterns** will be based on the order in which the notes were originally played. For instance, *Up* will play the notes in the originally played order, and *Down* will play the notes in reverse order.

On: The Arpeggiator plays notes according to the selected **Pattern**, sorted from lowest to highest, and ignores the originally played order.

Gate

[0%...100%]

This sets the length of the arpeggiated notes, as a percentage of the **Resolution**.

Sync Notes

[Off, On]

Off: The arpeggiator starts immediately when the first note is played, and does not synchronize to any Motion Sequences or itself when latched. You could use this if you were playing with a human drummer and needed to reset the arpeggiator rhythm to the drummer's beat periodically.

On: The arpeggiator will synchronize to either sounding Motion Sequences or itself when latched. When synchronizing to Motion Sequences, the first note will sound when played, but subsequent arpeggiator-generated notes will be in sync with the Motion Sequence. When playing a latched arpeggiator, new notes will sound when the arpeggiator beat comes around; the arpeggiator's rhythm is not disturbed by playing new notes.

Latch

[Off, On]

Off: The Arpeggiator will only play as long as notes are being held on the keyboard (or via the damper pedal).

On: The Arpeggiator will continue to play after notes are released.

Chord

Chord

A: Chord			
Chord: On		Fixed Vel: Off	
Note	Vel	Note	Vel
1	Off 127	3	Off 127
2	Off 127	4	Off 127
HOLD CHORD BUTTON & PLAY NOTES			

A: Chord			
Chord: On		Fixed Vel: Off	
Note	Vel	Note	Vel
5	Off 127	7	Off 127
6	Off 127	8	Off 127
HOLD CHORD BUTTON & PLAY NOTES			

Chords let you play up to 8 notes from a single key. Each Program stores its own Chord, and Chord can be enabled or disabled separately for each Program.

The lowest note of the chord is transposed to match the note played on the keyboard. Higher notes are transposed accordingly. For instance, let's say that the stored chord is F4, Bb4, and Eb5. If you play a D3 on the keyboard (or via MIDI), the resulting chord will be D3, G3, and C4.

When Chord is On, the normal Voice Assign settings still apply (see "Voice Assign" on page 10). For example, if the Voice Assign **Mode** is set to *Poly*, you can play multiple notes at once, each with its own chord. If **Mode** is set to *Mono*, and **Legato** is *On*, you can play legato phrases using the chord.

Chord (CHORD)

[Off, On]

Turn the chord on and off via the **CHORD** button. To view the page without changing on/off, use **ENTER + CHORD**.

Fixed Vel

[Off, On]

Off: the stored velocities are scaled by the velocity of the played note. A played velocity of 127 results in the full stored velocity values; lower played velocities scale the stored values downwards.

On: the stored velocities are used verbatim, unaffected by the note that triggers the chord.

Note 1-8

[C-1...G9]

These are the eight notes of the chord.

Vel 1-8

[1...127]

Each note in the chord can have its own velocity.

Entering a chord from the keyboard

1. Hold the **CHORD** button.

Its LED will flash.

2. Play the desired notes, either all at once or one by one up to the maximum of eight notes.

Both notes and velocities are recorded.

3. After playing the desired notes, release the **CHORD** button.

The **CHORD** button LED is lit solidly, and the Chord is turned on.

Layer Rotate

Layer Rotate

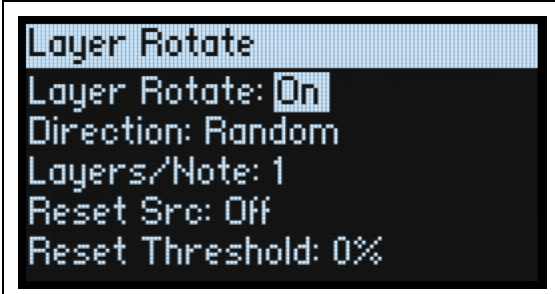

Press **LAYER ROTATE** to go to this page.

The multi/poly has four Layers, A/B/C/D. Naturally these can create normal layered sounds, as well as velocity and keyboard splits. Layer Rotate is a new possibility: flexible round-robin for Programs.

With Layer Rotate, you can set up two, three, or four Layers with different Programs and cycle through them with each key press. Play them in repeating or random order. Trigger one, two, or three Programs at every step of the cycle. Use Layer Rotate together with the Arpeggiator for mind-bending patterns.

As you play, the Layer LEDs will blink slightly to indicate which are being triggered.

Layer Rotate

[Off, On]

To turn Layer Rotate on and off from the front panel, **SHIFT**-press or double-press the **LAYER ROTATE** button.

Direction

[Forward, Backward, Forward/Backward, Random]

This controls the order in which the Layers are played.

Forward: Layers are played in the order A, B, C, D, A etc.

Backward: Layers are played in the order D, C, B, A, D etc.

Forward/Backward: Layers are played in the order A, B, C, D, C, B, A, B etc.

Random: Layers are played in random order.

Layers/Note

[1...3]

This determines how many Layers will be triggered with each note.

Reset Src

[List of modulation sources]

You can use this to reset the pattern, for consistency in a MIDI sequence or for other creative uses.

Reset Threshold

[-100...0...+100%]

This sets the modulation level which will reset the pattern.

When the threshold is *positive* (or 0), the pattern resets when the value passes through the threshold moving upwards. In other words, if the value has been below the **Threshold**, and then changes so that it is equal to or greater than the **Threshold**, the pattern resets.

When the threshold is *negative*, the pattern resets when the value passes through the threshold moving downwards. In other words, if the value has been above the **Threshold**, and then changes so that it is equal to or below the **Threshold**, the pattern resets.

Layer Rotate

Note: modulation sources may not always reliably reach the extreme values of +100 or -100. This can happen due to smoothing, or with LFOs when using certain shapes and faster speeds. If this is the case, **Thresholds** of +100 or -100 will cause inconsistent behavior. To avoid this issue, reduce the **Threshold** until the pattern resets consistently.

Effects

Overview

Each Layer has its own **PRE FX**, **MOD FX**, and **DELAY**. Additionally, the Performance has a master **REVERB** and parametric EQ. See “Structure” on page 3.

SHIFT-press or double-press the effects buttons to turn them on and off.

Main page

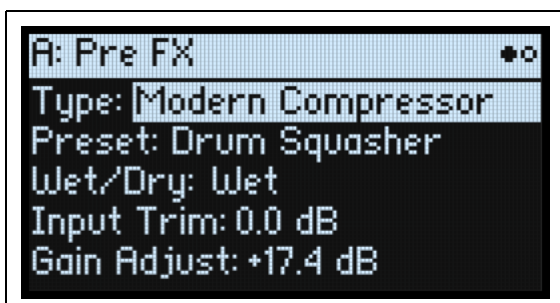

Type

[List of Effects]

For each effect, you can select a **Type** (or “algorithm”) and a **Preset** within that **Type**. For full lists of Effect Types, see “Pre FX,” “Mod FX,” “Delay,” and “Master Reverb,” below.

“All” types (*Delay All*, *Chorus All*, etc.) let you select **Presets** from all related algorithms.

Preset

[List of Presets]

These are the presets available for the selected **Type**.

Wet/Dry (WET/DRY)

[Dry, 1:99...99:1, Wet]

This appears for the Pre FX, Mod FX, and Delay. It controls the balance between the original signal (*Dry*) and the effected signal (*Wet*). For the Master Reverb, this knob controls Send levels instead; see “Reverb Sends,” below.

Level controls

Additional level-related parameters may be available on-screen, depending on the effect **Type**.

Input Trim

[-Inf, -84.9...0.0 dB]

This controls the volume level into the effect. Use this to alter the response of effects such as the *Waveshaper*, or to compensate for gain increases in effects such as the *Talking Modulator*.

Volume

[-Inf, -84.9...+12.0 dB]

This controls the post-**Drive** output of the **Guitar Amp**. Use it to compensate for level changes caused by **Drive**.

Output Level

[-Inf, -84.9...0.0 dB]

This controls the output volume from the effect. Use it to compensate for level changes in effects such as the *Waveshaper*.

Effects

Gain Adjust

[-Inf, -84.9...+24.0 dB]

This is similar to Output Level, but provides up to 24dB of gain. It appears only for the **Modern Compressor**.

Reverb Sends

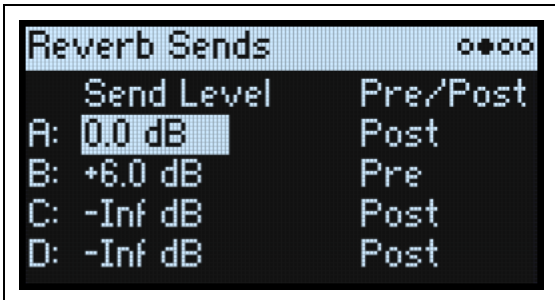

	Send Level	Pre/Post
A:	0.0 dB	Post
B:	+6.0 dB	Pre
C:	-Inf dB	Post
D:	-Inf dB	Post

Send Level A/B/C/D (REVERB: SEND)

[-Inf, -84.9...+6.0 dB]

This appears for the Master Reverb only. It controls the amount of signal sent from each of the Layers to the Master Reverb.

Pre/Post A/B/C/D

[Pre, Post]

This determines where the Send's signal comes from.

Pre: the signal is routed to the Send **before Layer Volume** is applied. This means that the Send Level is independent of Layer Volume. For 100% wet reverb, use *Pre* and then turn **Layer Volume** all the way down.

Post: the signal is routed to the Send **after Layer Volume** is applied. This is the default. As you increase or decrease Layer Volume, the proportion of the dry and reverberant sounds remains the same.

Edit page

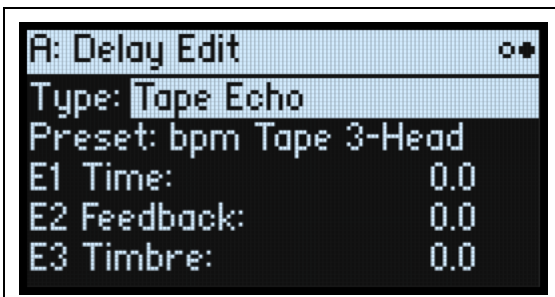

F: Delay Edit	
Type:	Tape Echo
Preset:	bpm Tape 3-Head
E1 Time:	0.0
E2 Feedback:	0.0
E3 Timbre:	0.0

The **EDIT 1/2/3** controls (E1/E2/E3 on the display) are macros which may control multiple internal parameters, and which may be set up differently for each **Preset**. There are general conventions for the **EDIT** knobs of each effect **Type**, as reflected in the on-screen labels.

Pre FX

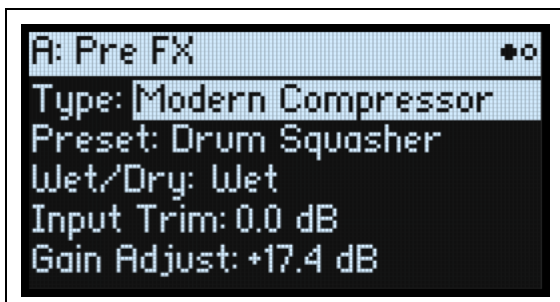

Decimator

This stereo effect models vintage digital gear, lowering the sampling frequency and reducing bit depth.

Graphic EQ

This is a stereo graphic EQ with macro controls.

Guitar Amp

This mono effect models a selection of guitar amps and speaker cabinets, for everything from subtle saturation to roaring distortion.

Modern Compressor

This is a stereo compressor with a modern sound.

Parametric EQ

This is a stereo EQ with a single adjustable parametric band. Presets may include additional EQ.

Red Compressor

Need to play chordal passages with smooth, even dynamics? Then, look no further: this mono compressor is modeled on a pedal whose clean sound made it hugely popular.

Ring Modulator

This stereo effect creates a metallic sound by modulating the input via an LFO-controlled oscillator.

Tremolo

This stereo effect modulates volume with an LFO, optionally controlled by an envelope follower.

Wave Shaper

This stereo effect is very sensitive to input level. Different table selections generate various types of overtones and distortion.

Vintage Distortion

This models four different stomp-box distortion pedals: Valve, Driver, Fuzz, and Scream.

Mod FX

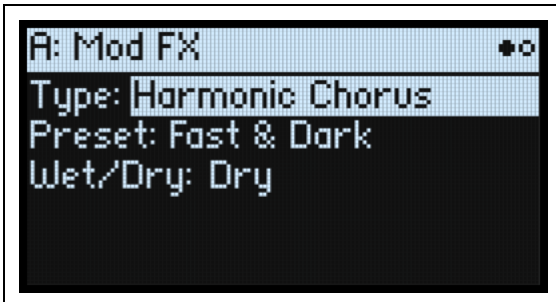

Black Chorus/Flanger

This is modeled after a classic mono-in, stereo-out chorus known for both crystal-clean tone and quiet operation, and especially well-suited to tine electric pianos.

Black Phase

This mono phaser is inspired by a classic European pedal effect.

CX-3 Vibrato/Chorus

This effect models the scanning chorus and vibrato circuitry of a vintage organ.

EP Chorus

This is inspired by a rare chorus built into a famous modified tine piano.

Harmonic Chorus

This stereo effect applies chorus only to higher frequencies—particularly useful for bass sounds. Some presets use feedback to turn the chorus into a flanger.

Modern Chorus

This stereo effect adds thickness and warmth to the sound by modulating the delay time of the input signal.

Modern Phaser

This is a modern, stereo phaser effect.

Orange Phase

This is a model of a classic, orange-colored mono phaser pedal. It's superseded by the "V2" version below, but is still available for compatibility with older sounds.

Orange Phase V2

This is an improved model of a family of mono phaser pedals—in "90" and "100" versions—which are favorites on many recordings. It's useful for adding sparkle, animating chord passages, and widening and fattening the sound.

Polysix Ensemble

This models the mono-in, stereo-out ensemble effect built into the classic Korg Polysix synthesizer.

Small Phase

This models a classic mono phaser made in New York City during the 70s, with its warm, rich tone and liquid transparency.

Talking Modulator

This mono effect applies vowel formant filters, like a human voice, to the input.

Vintage Chorus

This models a mono chorus best-known for being built into a guitar amp. **Speed** and **Depth** provide a broader range of sounds than the original device.

Vintage Flanger

A model of a truly classic mono analogue flanger. This amazing stompbox's bucket-brigade technology provides a sweeping, whooshing sound, perfect for chords.

Vintage/Custom Wah

This stereo effect models the tonal character of a vintage wah pedal.

Vox Wah

This effect is modeled on the unique “throaty” tones of two legendary VOX wah pedals: the V847 and the V848 Clyde McCoy model.

CX-3 Rotary Speaker

This effect models a vintage rotary speaker used with tonewheel organs.

Delay



L/C/R Delay

This mono-in, stereo-out multitap delay has three taps panned to the left, right, and center respectively.

Multiband Mod. Delay

This monster effect divides the input signal into four frequency bands, with a modulatable delay for each band. It can produce everything from complex, frequency-specific delays to thick choruses.

Reverse Delay

This effect includes a reverse delay followed by additional left and right delays. Presets provide various feedback options.

Stereo/Cross Delay

This true-stereo delay provides up to 2,730 msec of delay time.

Tape Echo

This effect models a tape echo with up to three playback heads, including tape saturation.

Master Reverb

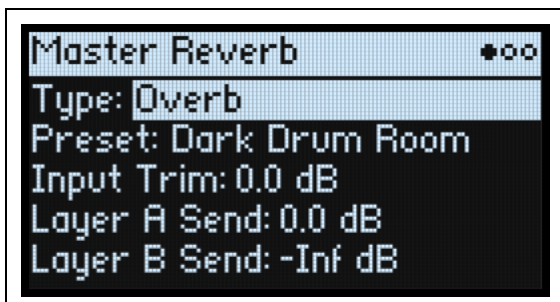

Early Reflections

This provides different early reflection patterns, useful for small ambiences, gated reverbs, and reverse effects.

Overb

The Overb features a high-quality, diffusion-based reverb core, including randomization for richer and smoother reverb timbres.

Master EQ

Performances include a dedicated four-band parametric EQ. To edit the EQ:

1. Press **REVERB**.
2. Use **PAGE+/-** to go to the Master EQ page.

The Master EQ page will appear.

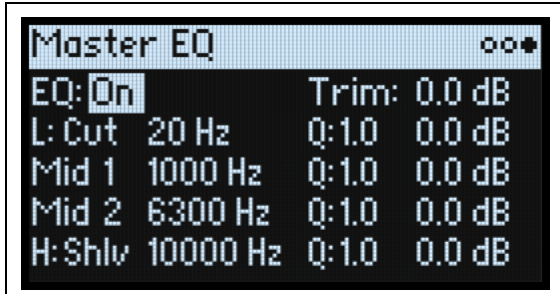

EQ

[Off, On]

This enables and disables the Master EQ.

Trim

[-Inf, -84.9...0.0 dB]

Use this volume control to compensate for EQ boosts.

L (Low) and H (High)

(Mode)

[Pk, Shlv, Cut]

The Low and High bands can be set to *Pk* (Peaking), *Shlv* (Shelving), or *Cut* (Low cut/High cut).

(Frequency)

[20...20,000 Hz]

If **Mode** is set to *Pk* (Peaking), this sets the band's center frequency; if **Mode** is set to *Shlv* or *Cut*, it sets the cutoff frequency.

Effects

Q

[0.5...10.0]

This controls the width of the band when **Mode** is set to *Pk* (Peaking).

(Gain)

[-18.0...+18.0 dB]

This sets the amount of cut or boost for the band.

Mid 1 and Mid 2

These bands are always in Peaking mode. Otherwise, their controls are similar to Low and High, as described above.

Randomize

Randomize uses a combination of preset selection and select value randomization, rather than direct randomization of all parameters.

Using Randomize

To randomize the entire Performance:

1. Press the  (Randomize) button.

The Randomize page will appear, with **Scope** set to *Performance* by default. If **Scope** has been previously changed to another setting, hold  and press **PERFORM**.

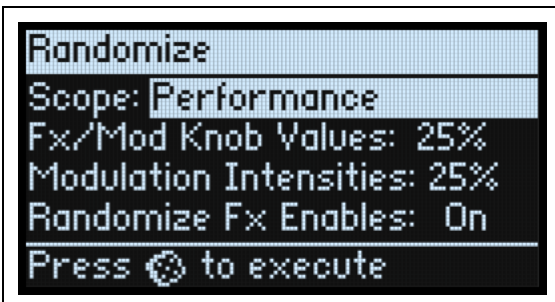

Depending on the Scope, additional settings may appear:



Fx/Mod Knob Values randomizes the Mod Knobs (Program and/or Performance, according to **Scope**) and Effects Edit 1/2/3 by the specified percentage.

Modulation Intensities randomizes the standard LFO and Envelope intensities for Filter, Amp, Osc 1/2, and Pitch.

Randomize Fx Enables controls the On/Off settings for the Effects (with probability weighted towards On).

2. Press  again to randomize everything in all layers, and then **ENTER** to confirm.

To randomize a specific section of the synth:

1. Press and hold .
2. While holding , press the button for the desired section (**PERFORM**, **OSC**, **SEQ STEPS**, **ARPEGGIATOR**, **FILTER TYPE**, **AMP**, **PITCH**, **LAYER A/B/C/D**, or any Effect); press a Motion Sequence Lane button (pressing **SHIFT** is not required for Lane selection here); or move a Filter or MOD knob.

The Randomize page will appear, with the selected **Scope**. You can still change the **Scope** again, if desired. Additional **Scope** options are available from the on-screen menu.

3. Press  to execute the randomization, and then **ENTER** to confirm.

Utility

System Setup



Set List

[List of Set Lists]

This selects the current Set List, which maps Performances to the SET LIST buttons. You can store many Set Lists, and change between them as you like.

Octave (OCTAVE +/-)

[-4...+4]

This shifts the keyboard up or down by up to four octaves. It's generally controlled by the front panel **OCTAVE** buttons, although these can optionally control scale selection, instead; see "Octave Selects Scale" on page 122. When controlling Octave, the **OCTAVE** buttons change color according to the degree of transposition:

Octave	Color
-1/+1	Green
-2/+2	Yellow
-3/+3	Orange
-4/+4	Red

Transpose

[-12...+12 semitones]

This adjusts the pitch in semitone steps over a ± 1 octave range.

Note: Transpose is affected by the **Convert Position** setting; see "Convert Position" on page 119.

Tune

[-50 (427.47Hz)...+50 (452.89Hz)]

This adjusts the overall tuning of the entire multi/poly in one-cent units, over a range of ± 50 cents. (A cent is 1/100 of a semitone.) At the default of 0, A4 = 440 Hz.

 The value shown for A4's frequency assumes that the scale is set to Equal Temperament. If a different scale is selected, the actual frequency of A4 may be different.

System ID

[1...254]

This number identifies the multi/poly to computer hosts. If you have multiple multi/polys, set each to a different number.

CMT ID

[0...255]

CMT stands for "Component Modeling Technology." This ID determines the particular set of Virtual Voice Cards for the instrument. For more information, see "Virtual voice cards and drift" on page 57.

MIDI & USB



Global Channel

[1...16]

This is the basic MIDI channel for the multi/poly. It applies to:

- MIDI sent from the built-in keyboard and controllers (except for Program Mod Knobs)
- MIDI received by any Layer with **Use Global MIDI Channel** enabled
- MIDI CCs received by and sent from the Program Mod Knobs, for any Layer with **Use Global MIDI Channel** enabled
- Program Change (via Set Lists)
- Other global functionality, such as modulation of Master Reverb, Kaoss Physics, and System Exclusive

Local Control

[Off, On]

On: This is the default; the multi/poly's internal sounds will be played by the built-in keyboard and controllers. If you are playing the multi/poly by itself, leave this setting checked.

Off: The multi/poly's keyboard and controllers, including the Mod Knobs, will be disconnected from the internal sounds. MIDI transmit and receive will continue to work normally. Use this setting if loop-back from an external sequencer causes duplicate notes.

Clock

[Internal, External, Auto]

Internal: The multi/poly will use the Performance's Tempo setting (also shown and controlled by the **TAP TEMPO** button). Use this when playing the multi/poly by itself, or when you want the multi/poly to control the tempo of external MIDI devices such as a sequencer or drum machine.

External: The multi/poly tempo will synchronize to incoming MIDI Clock messages from either 5-pin MIDI or USB. If MIDI clocks are not being received, tempo-related features will not function.

Auto: This combines the functionality of *Internal* and *External*, so that you don't have to manually switch between the two:

- If MIDI Clocks are not being received, the multi/poly uses its internal tempo.
- If MIDI Clocks are being received, they control the tempo. If the clocks stop for more than 500 ms, the multi/poly switches back to internal tempo.

USB Network

[RNDIS, NCM]

The multi/poly uses USB networking to communicate with the Editor Librarian and Updater software on MacOS and Windows computers. This selects the network protocol which will be used. Some computer operating systems may require one setting or the other; for the latest information, please see the documentation included with the Editor Librarian or Updater.

 Changes to this parameter take effect only after the multi/poly has been turned off and restarted.

RNDIS: This is the RNDIS protocol, primarily for use with Windows 7 and 8.

NCM: This is the Network Control Model protocol, for use with MacOS and Windows 10.

Controllers

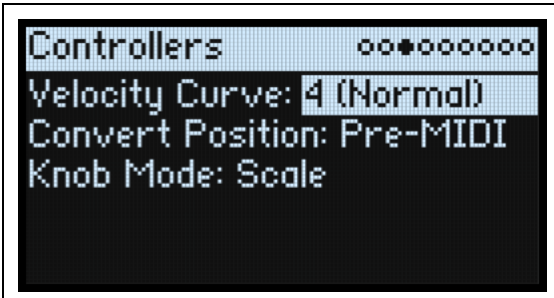

Velocity Curve

[1 (Heavy), 2, 3, 4 (Normal), 5, 6, 7, 8 (Light), 9 (Wide)]

This controls how the volume and/or tone responds to variations in keyboard playing dynamics (velocity). Choose the curve that is most appropriate for your playing strength and style.

Velocity Curves always work the same way between the built-in keyboard and the synth engine. The way that they relate to MIDI, however, is tied to the **Convert Position** setting (see below).

Velocity curves

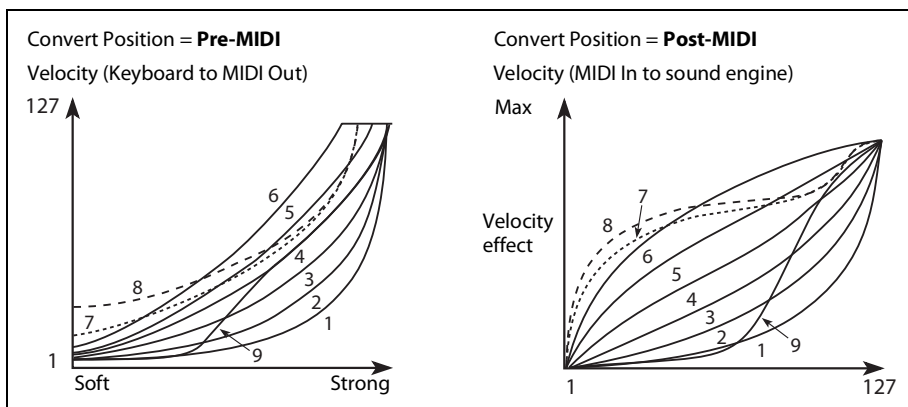

1 (Heavy), 2, 3: These are for heavy playing; most of the variation occurs in the upper velocity range.

4 (Normal): This is the default.

5, 6: These are for lighter playing.

7: This is for very light playing, at the expense of control in the middle of the range.

8 (Light): This curve produces the most uniform output, for when velocity sensitivity is not desired.

9 (Wide): This curve is designed for the heavier touch of external weighted keyboards.

AT Curve (Aftertouch Curve)

[1 (Heavy), 2, 3 (Normal), 4, 5 (Light), 6 (24-step), 7 (12-step), 8 (Random)]

This controls how the sounds respond to variations in pressure (aftertouch) applied while playing a note on an external MIDI keyboard. Choose the curve that is most appropriate for your playing strength and style.

Note: Aftertouch is supported via MIDI only.

Utility

Aftertouch curves

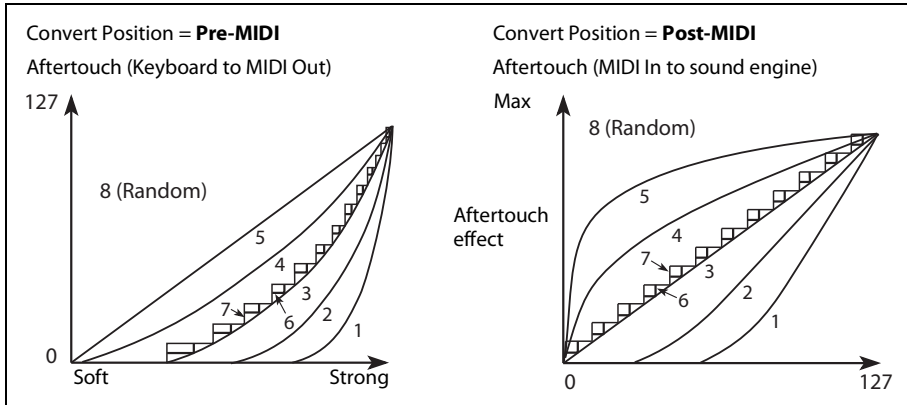

1 (Heavy), 2: These are for heavy playing; most of the variation occurs with stronger pressure.

3 (Normal): This is the default.

4, 5 (Light): These produce changes even with light pressure.

6 (24-step), 7 (12-step): These curves result in 24 or 12 steps, respectively. If Aftertouch is modulating pitch with an intensity of one octave, 7 (12-step) lets you use Aftertouch to play a chromatic scale. (For similar results, you could also use a Mod Processor set to Quantize.)

8 (Random): This is a random curve. Use this to create special effects, or for applying unpredictable modulation.

AT Source (Aftertouch Source)

[Off, Channel, Poly, Chan+Poly]

This lets you instantly re-configure the synth to take advantage of controllers with Poly Aftertouch.

Off: All aftertouch will be ignored.

Channel: The mod source “Aftertouch” receives Channel Aftertouch. Poly Aftertouch can still be used via the dedicated Poly AT mod source.

Poly: The mod source “Aftertouch” receives Poly Aftertouch. Channel Aftertouch is ignored.

Chan+Poly: The mod source “Aftertouch” receives both Channel and Poly Aftertouch. If both are sent simultaneously, the most recent value is used.

Convert Position

[Pre-MIDI, Post-MIDI]

This setting controls how the **Velocity Curve** and Performance and System Setup **Transpose** and **Octave** settings work. You can think of these as a set of MIDI effects processors, which can be used in one of two places within the multi/poly.

Note: Regardless of the **Convert Position**, **Transpose/Octave** and **Velocity Curve** always apply when playing internal sounds directly from the multi/poly keyboard.

Pre-MIDI: This is the default. **Transpose/Octave** and **Velocity Curve** affect MIDI *output*.

Convert Position = Pre-MIDI

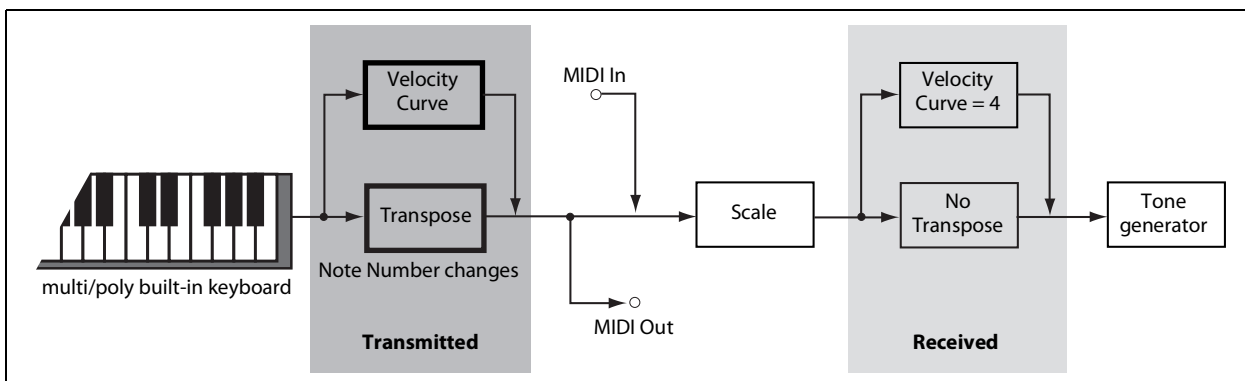

Post-MIDI: **Transpose/Octave** and **Velocity Curve** affect MIDI *input*. Use this to adjust response to an external MIDI controller.

Utility

Post-MIDI also shifts Global and Performance Scales to match the **Transpose** setting—convenient for use with non-equal-tempered scales. See also “Transpose” on page 122.

Convert Position = Post-MIDI

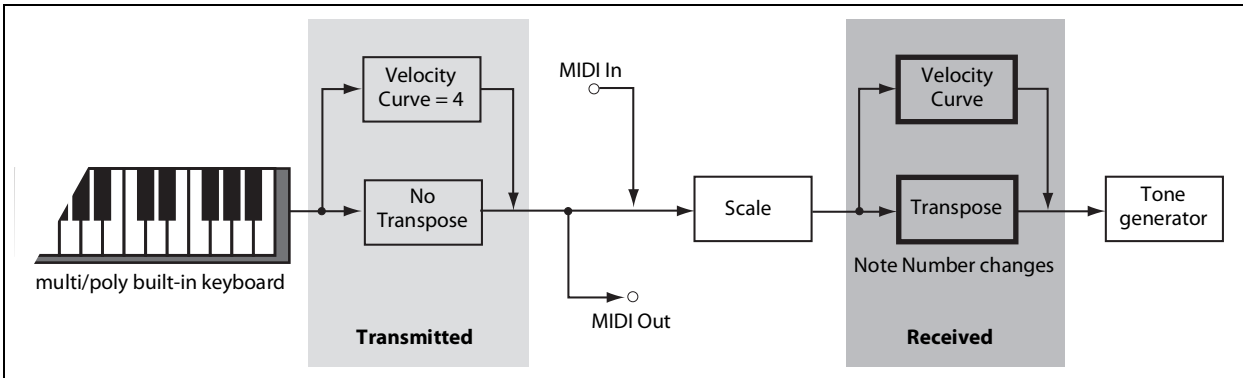

Knob Mode

[Scale, Jump]

When you switch to a new Performance or select a different Layer, Motion Sequence Lane, Effect, Envelope, LFO, etc., the parameter values “underneath” the front-panel knobs will change—but the physical knobs won’t move automatically. **Knob Mode** controls what happens when you move a knob.

Scale: This is the default. The physical position of the knob is mapped to the current parameter value. Moving the knob counter-clockwise goes from the current value to the minimum; moving clockwise goes from the current value to the maximum. If you turn the knob all the way to the left or right, the range is reset. See the graphic below.

Jump: When a knob is moved, the parameter value instantly changes to match the position of the knob.

Knob Mode set to Scale

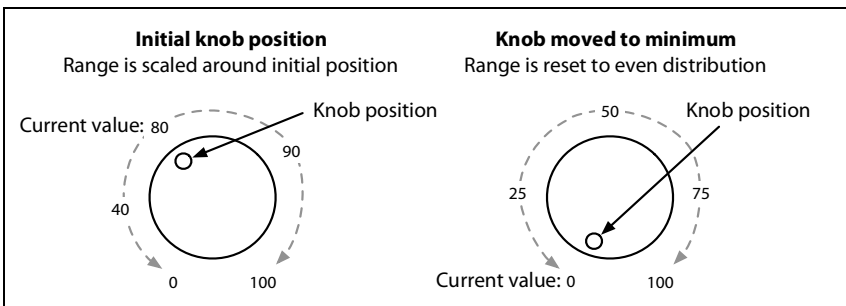

MIDI CC Assign

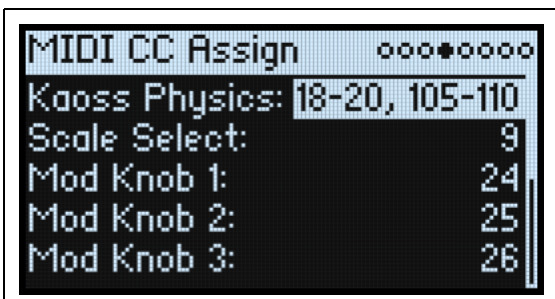

You can control Scale Select and each Mod Knob directly from MIDI CCs. These CCs edit the assigned parameters, just like moving the front-panel knobs. To modulate a parameter with variable intensity, and without causing edits to the sound, use modulation instead. Some dedicated CCs cannot be assigned (CCs 1, 7, etc.).

Function	Default CC assignment
Kaoss Physics	18-20, 105-110

Utility

Function	Default CC assignment
Scale Select	9
Mod Knobs 1...4	24...27

For Kaoss Physics, the first three CCs correspond to x/y position and finger on/finger off, and the last six CCs contain the “throw” information of release position, direction, and velocity.

Global Scale

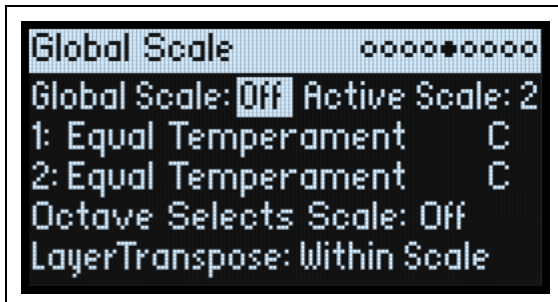

Global Scale

[Off, On]

On: The settings on this page control the instrument’s scales. Performance scales are ignored.

Off: The scale settings on this page are ignored.

Note: If both **Global Scale** and **Performance Scale** are *Off*, the system simply uses equal temperament.

Active Scale

[1, 2]

If **Global Scale** is *On*, this chooses which of the two scales below is used. You can control this via MIDI. See also “Octave Selects Scale,” below.

1 (Scale 1)

[List of Scales]

This selects the first Scale to be used. You can load and edit Scales using the Editor/Librarian application for macOS and Windows; for more information, see the Editor/Librarian manual.

Some of the factory Scales are described below.

Arabic: This includes the quarter-tone intervals used in Arabic music.

Pythagoras: Especially effective for melodies, this produces 11 completely pure fifths, at the expense of other intervals—thirds in particular. To maintain the tuning of the octave, the final fifth—from sharp four to sharp root—is also quite flat.

Werkmeister (Werkmeister III), Kirnberger (Kirnberger III): These are “Well-Tempered” tunings from the Baroque period.

Pelog: This Indonesian gamelan scale uses seven notes per octave. When Key is set to C, use the white keys. The black keys will play the equal tempered pitches.

Pure Major, Pure Minor: These are Just Intonations optimized for major and minor keys, respectively. Unlike the other scales, they maintain the A4 tuning (e.g. A=440 Hz) as set by the Global **Tune** parameter (see “Tune” on page 116). Because of this, the root note of the selected **Key** may shift from its equal-tempered pitch.

Slendro: This Indonesian gamelan scale has five notes per octave. When **Key** is set to C, use C, D, F, G and A. Other notes will play the normal equal-tempered pitches.

Stretch: In this acoustic piano tuning, notes below the middle of the keyboard are progressively more flat, and notes above the middle are progressively more sharp.

Utility

(Key)

[C...B]

This controls the root key of the Scale. **Key** applies only if the **Scale Type** is *Octave Scale* or *Octave Scale, A=Master Tune*. If the **Type** is *128 Note Scale*, **Key** is ignored. For more information, see the Editor/Librarian manual.

Note: Specific combinations of **Scale** and **Key** may skew the reference tuning pitch. For example, A4 might become 442 Hz, instead of 440 Hz. Use **Master Tune** to correct this, if necessary. Alternatively, when tuning to A, use the *Octave Scale, A=Master Tune Scale Type*.

2 (Scale 2)

(Key)

These are the second **Scale** and its associated **Key**.

Octave Selects Scale

[Off, On]

If this is *On*, the **OCTAVE** down button selects Scale 1, and **OCTAVE** up selects Scale 2 (for either the Global or Performance scale, depending on which is in use). **SHIFT+OCTAVE** then performs octave up/down functionality.

Transpose

[Transposes Scale, Within Scale]

This parameter determines how the Performance and Program **Transpose** parameters interact with the Scale and Key. *Within Scale* means that transposition uses intervals within the current scale. This option works well if you are using non-equal-tempered scales and want to build parallel intervals (such as “fat fifths”) into your sounds. For example, let’s say that you are using Just Intonation in the key of C. If you transpose one of the Programs up by 7 semitones and play a C, the result will be two notes: C, and G 2 cents sharp (the Just Intonation fifth).

Transposes Scale means that the Scale’s Key changes to match the transposition. This option is useful if you play in non-equal-tempered scales and transpose entire songs—to accommodate singers, for example. In other words, let’s say that the **Key** is set to C, and the third note of the scale (E) is 50 cents flat. If you transpose up by 2 semitones, and play an E, the result will be an F# 50 cents flat—still the third note of the scale. For this application, it’s also best to set the **Convert Position** to *Post-MIDI*; for more information, see “Convert Position” on page 119.

Preferences

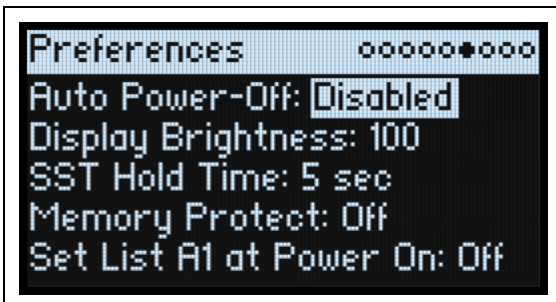

Auto Power-Off

[Disabled, 4 Hours]

By default, to conserve energy, the multi/poly will automatically turn off after about four hours have elapsed without use of the front panel, keyboard, or MIDI input. You can disable this feature, if desired.

 When the power turns off, any un-saved edits or settings will be lost. Make sure that you save important settings before this occurs.

Display Brightness

[0...100]

This controls the brightness of the OLED display.

Utility

SST Hold Time

[0 msec...60 sec]

This controls the duration of Smooth Sound Transitions. It sets how long reverbs, delays, and note releases continue to ring out after a new sound has been selected. The timer starts after all notes from the previous sound are no longer being held down, and the sustain pedal is released.

Memory Protect

[Off, On]

When this is *On*, Write functionality is disabled.

Set List A1 at Power On

[Off, On]

Off: At power-up, the last-used sound will be selected.

On: At power-up, Set List Slot A1 will be selected.

System Stats

This page provides diagnostic information for the system.

CPU Usage

[0.00...100.00%]

This shows the percentage of available processing power being used for voices and effects.

Temperature

[°C]

This shows the CPU's temperature.

Sounding Voices

[0...60]

This shows the number of voices currently being played.

Voice Stealing

[0...60]

Sometimes, if a lot of voices are already sounding, there won't be enough free power to play a new voice. When this happens, the system stops older or lower-priority voices so that the CPU can be used for the new voice instead. This is called "voice stealing." This shows the amount of voice stealing, in real time.

Available Storage

[size in MB]

This shows the amount of free space available for storing sound data, including Wavetables, Performances, Programs, etc.

About

This page shows the software version number and abbreviated credits. The multi/poly is the result of a team effort, built through the talents of many more people than can be listed on-screen!

USB

You can connect the multi/poly to computers via USB, to send and receive MIDI and to edit and organize sound data with the multi/poly Editor/Librarian.

MIDI

The multi/poly is a class-compliant USB MIDI device, and requires no driver for MIDI functionality.

Editor/Librarian

The multi/poly Editor/Librarian supports macOS and Windows, and is available as a download from www.korg.com. For more information, please see the documentation included with the download.

Specifications

System

Keyboard: 37-key semi-weighted keyboard (velocity and release-velocity sensitive)

Maximum Polyphony: 60 voices

Sound generating system: Analog modeling

Modulation

Controllers: Mod Wheel, Pitch Wheel, Kaoss Physics, 4x Mod Knobs

Other Sources: 4x Envelopes, 5x LFOs, 8x Mod Processors, 3x Key Track, Seq Lanes A-D, Step Pulse, Tempo, Program/Performance Note Count, Program/Performance Voice Count, Poly Legato, Velocity, Exponential Velocity, Release Velocity, Gate, Gate+Damper, Note-On Trigger, Note-On Trigger+Damper, Note Number, Aftertouch and Poly Aftertouch (external MIDI only), MIDI CCs +/-, MIDI CCs +

Destinations: Most parameters can be modulated, including parameters of individual Motion Sequence Steps. Depending on Motion Sequence length, there can be more than 1,000 potential modulation targets per Program.

Effects

Pre FX: Decimator, Graphic EQ, Guitar Amp, Modern Compressor, Parametric EQ, Red Compressor, Ring Modulator, Tremolo, Wave Shaper, Vintage Distortion

Mod FX: Black Chorus/Flanger, Black Phase, CX-3 Vibrato/Chorus, EP Chorus, Harmonic Chorus, Modern Chorus, Modern Phaser, Orange Phase, Orange Phase V2, Polysix Ensemble, Small Phase, Talking Modulator, Vintage Chorus, Vintage Flanger, Vintage/Custom Wah, Vox Wah, CX-3 Rotary Speaker

Delay: L/C/R Delay, Multiband Mod Delay, Reverse Delay, Stereo/Cross Delay, Tape Echo

Master Reverb: Early Reflections, Overb

Master EQ: 4-band parametric EQ

General

Inputs/outputs: Headphone (6.3 mm stereo phone jack), OUTPUT L/MONO and R (impedance-balanced 6.3 mm TRS phone jacks), DAMPER (6.3 mm phone jack, half-damper not supported), MIDI IN and OUT connectors, USB B port

Power supply: AC adapter (DC12V, 2500mA)

Power consumption: 5 W

Dimensions (W × D × H): 566 x 319 x 93 mm/22.28" × 12.56" × 3.66"

Weight: 3.5 kg/7.72 lb

Included items: AC adapter, Quick Start Guide, soft case

Accessories (sold separately): DS-1H damper pedal, PS-1 pedal switch, PS-3 pedal switch

* Specifications and appearance are subject to change without notice.

* All product names and company names are the trademarks or registered trademarks of their respective owners.

Model: multi/poly MIDI implementation chart

Function		Transmitted	Recognized	Remarks
Basic Channel	Default	1-16	1-16	Memorized
	Changed	1-16	1-16	
Mode	Default		3	
	Messages	X	X	
	Altered	*****		
Note Number		0-127	0-127	Some sounds will not play across the entire note range
	True Voice	*****	0-127	
Velocity	Note On	O 9n, V=1-127	O 9n, V=1-127	Received Note Off Velocity values are clipped at 64
	Note Off	O 8n, V=1-64	O 8n, V=0-127	
After Touch	Polyphonic (Key)	X	O	
	Channel	X	O	
Pitch Bend		O	O	
Control Change	1	O	O	Modulation
	7	X	O	Volume
	10	X	O	Pan
	11	X	O	Expression
	18, 19	O	O	Kaoss Pad X, Y
	64	O	O	Damper
	66	X	O	Sostenuto
	67	X	O	Soft
2-6, 8-9, 12-31, 32-63, 65, 67-95, 102-119	O	O	Assignable for controllers and modulation *1	
120, 121	X	O	All Sound Off, Reset All Controllers	
Program Change		O 1-64	O 1-64	Selects Slots in the current Set List
	True Number	*****	0-63	
System Exclusive		O	O	Kaoss Physics *2
System Common	Song Position	X	X	
	Song Select	X	X	
	Tune Request	X	X	
System Real Time	Clock	O	O	
	Commands	X	X	
Aux Messages	Local On/Off	X	X	
	All Notes Off	X	O (123-127)	
	Active Sense	O	O	
	System Reset	X	X	
Notes *1: Sent and received by Mod Knobs and Scale Select when assigned in UTILITY > MIDI CC Assign; also received as programmable modulation sources *2: Also supports universal system exclusive messages device inquiry, master volume, master fine tuning, and master coarse tuning				

Mode 1: Omni On, Poly
 Mode 3: Omni Off, Poly

Mode 2: Omni On, Mono
 Mode 4: Omni Off, Mono

O: Yes
 X: No

Consult your local Korg distributor for more information on the MIDI implementation.

KORG INC.

4015-2 Yanokuchi, Inagi-City, Tokyo 206-0812 JAPAN
© 2024 KORG INC.

www.korg.com
Published 10/2024